

Montážní návod

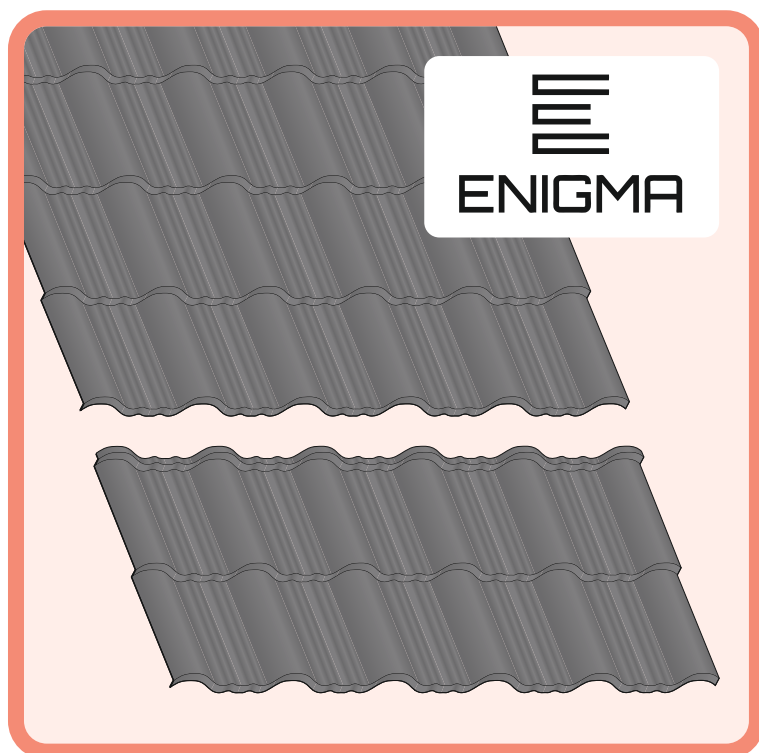

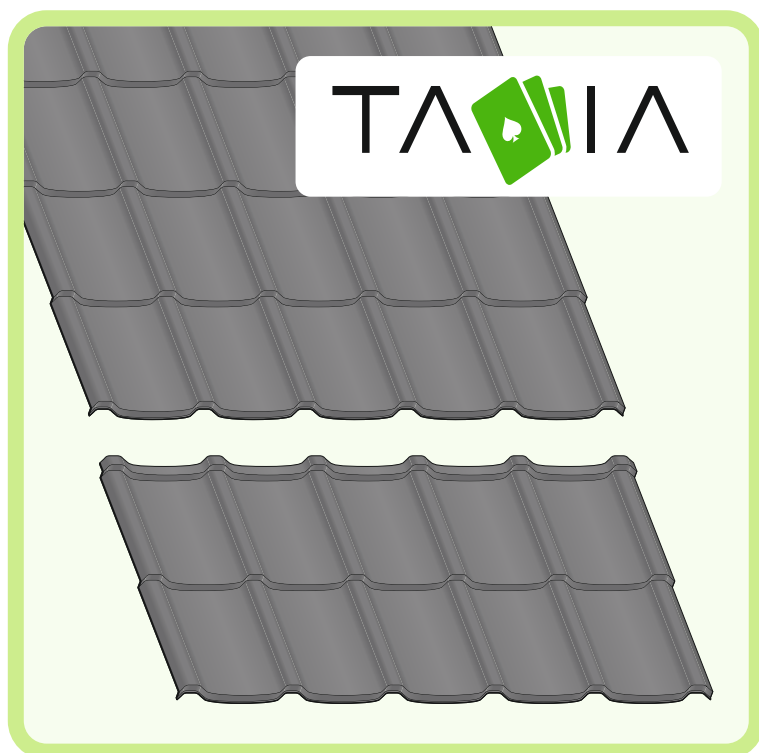

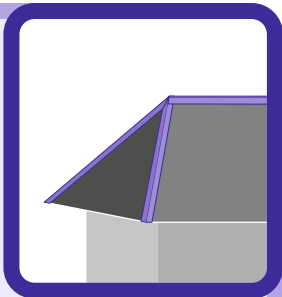
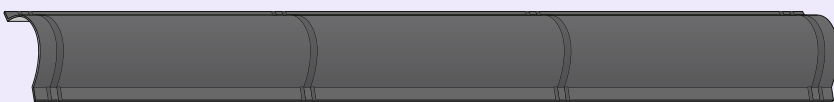
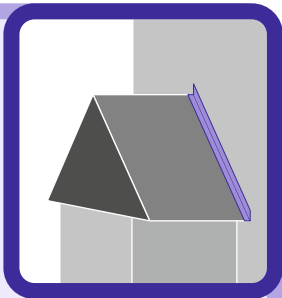
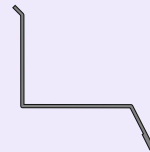
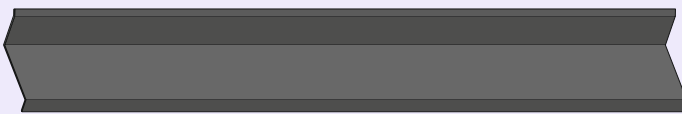
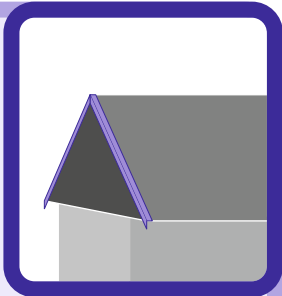
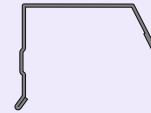
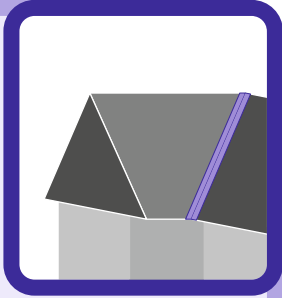
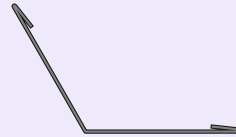
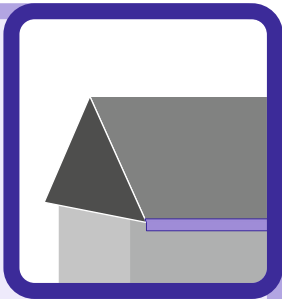
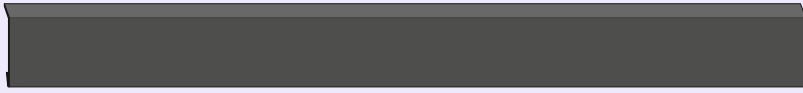
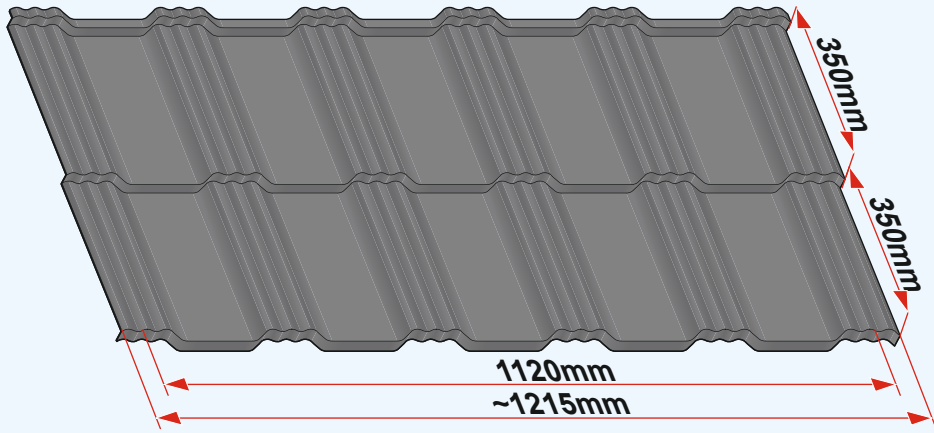

Germania
simetric

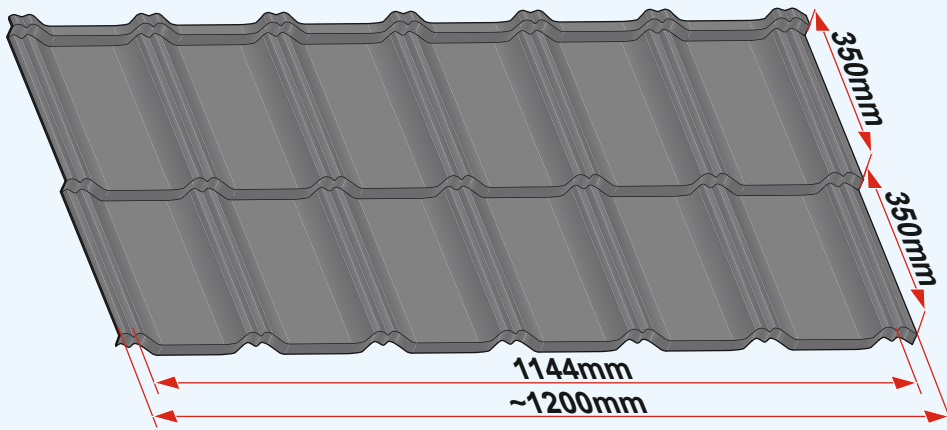
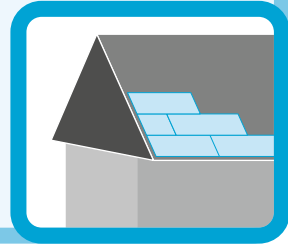

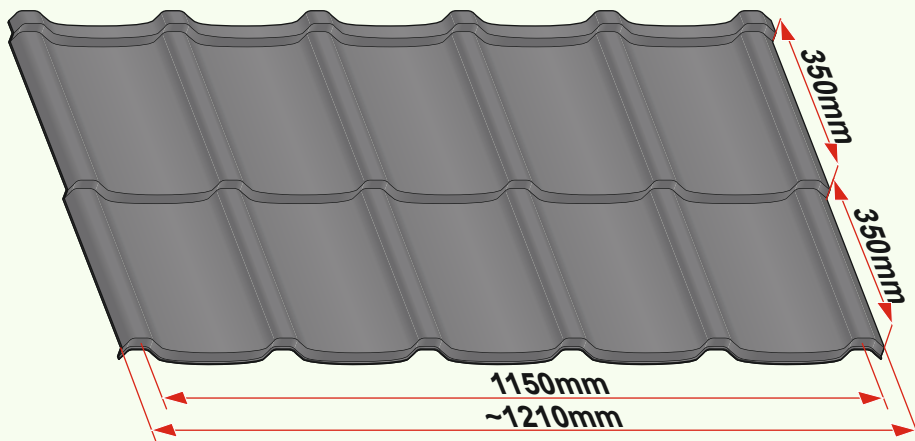
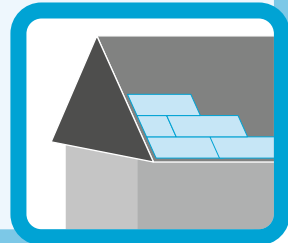

GERMAN
simetric

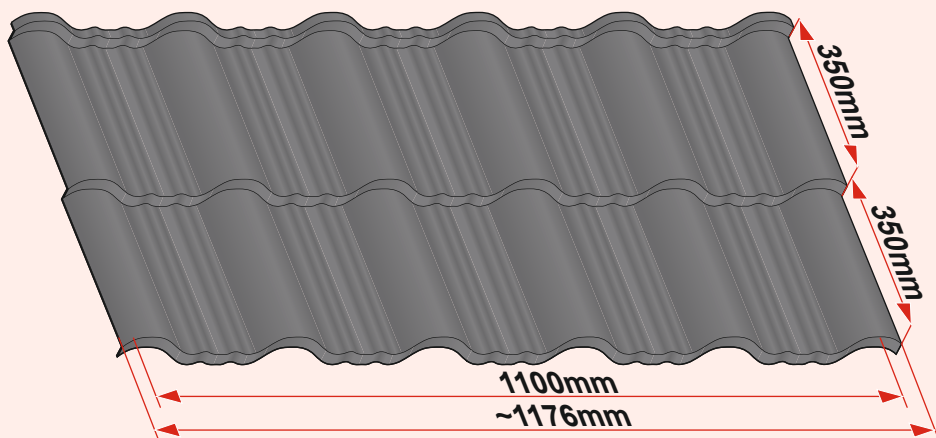
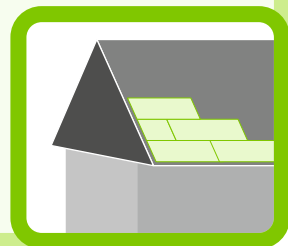

TAIA



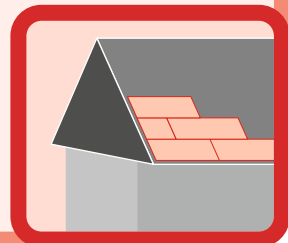

ENIGMA

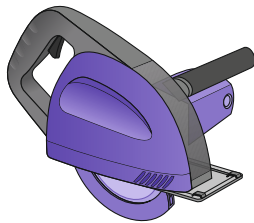

1

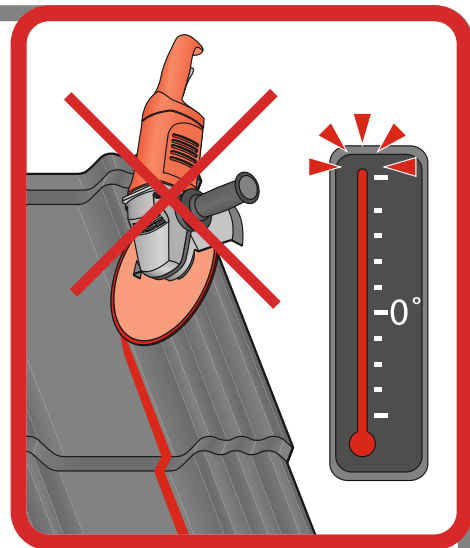
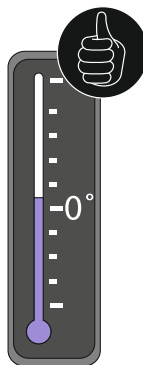
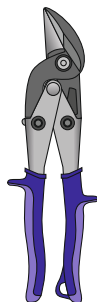
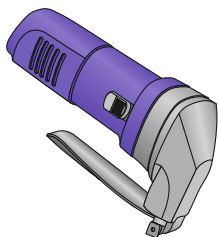

max4000r/min



2

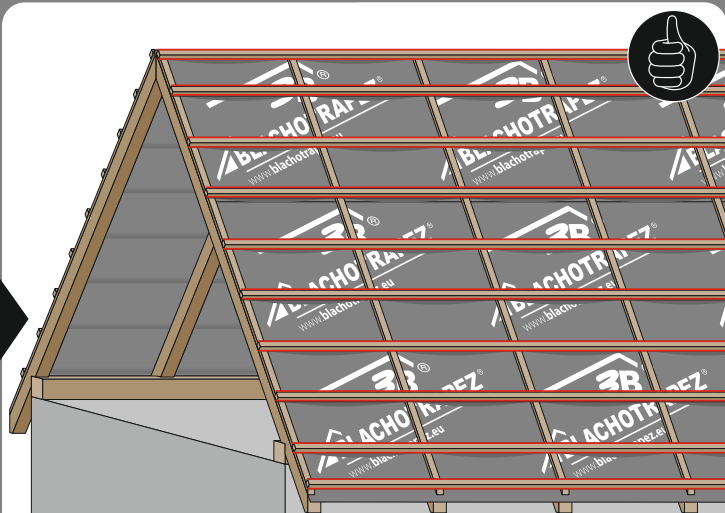
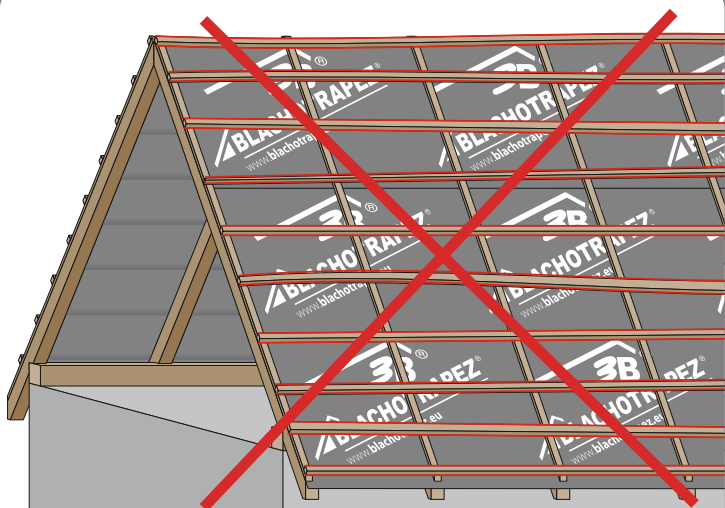
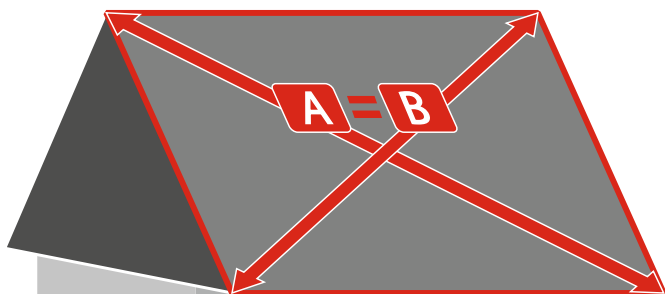

3a

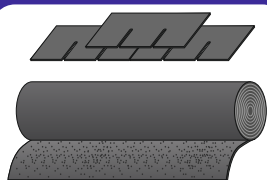
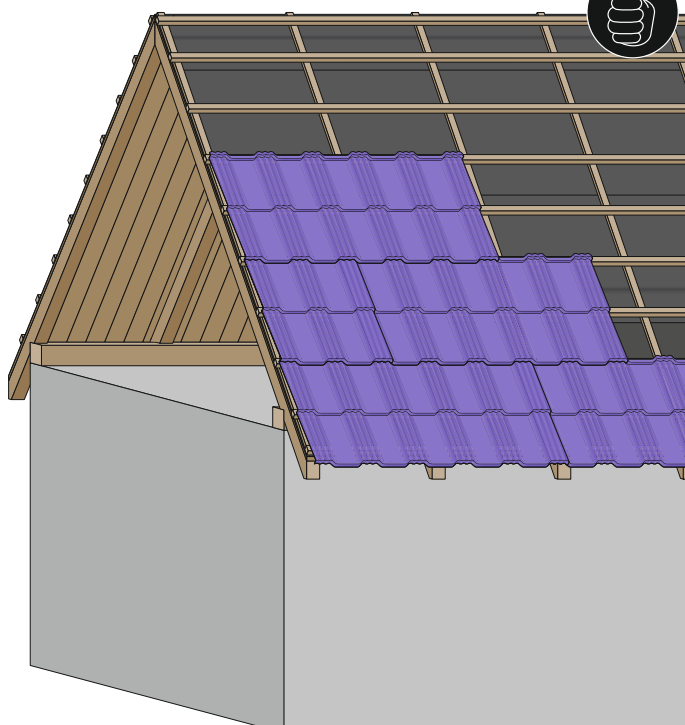
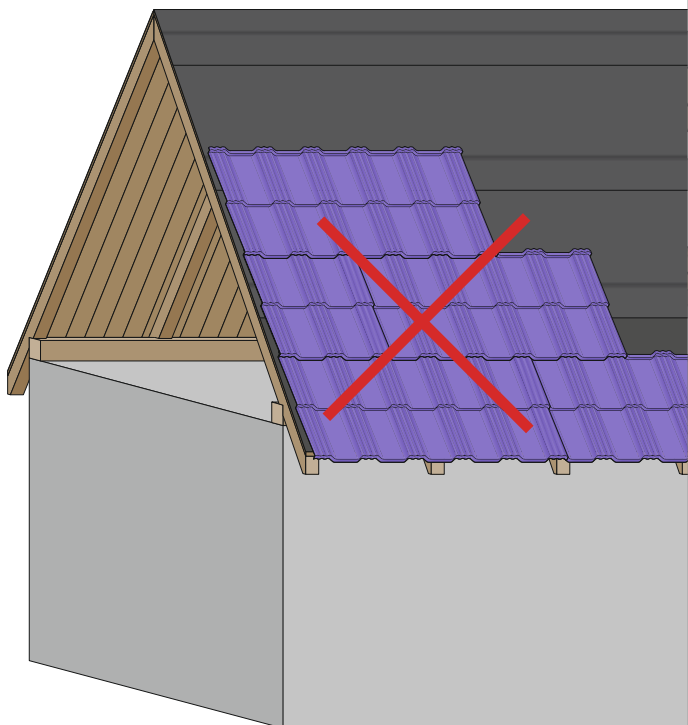
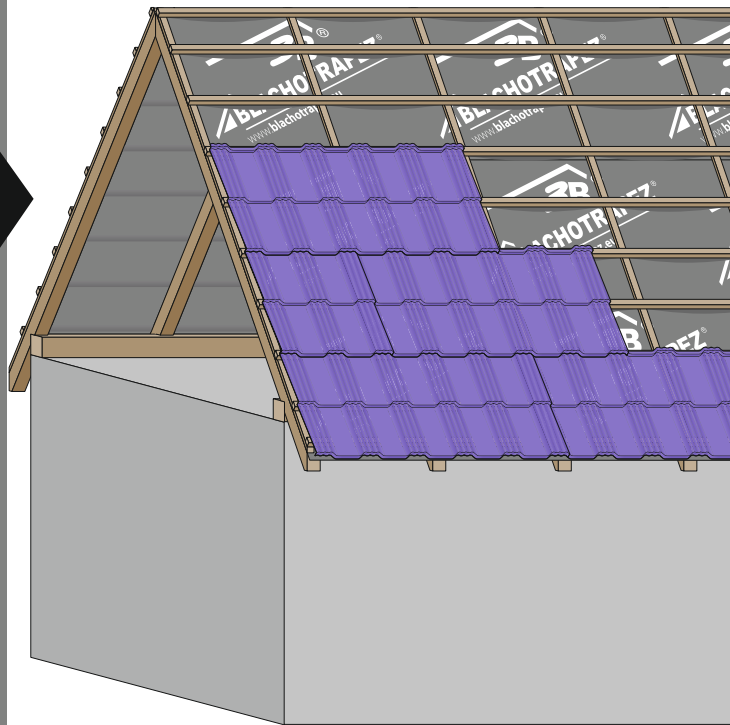
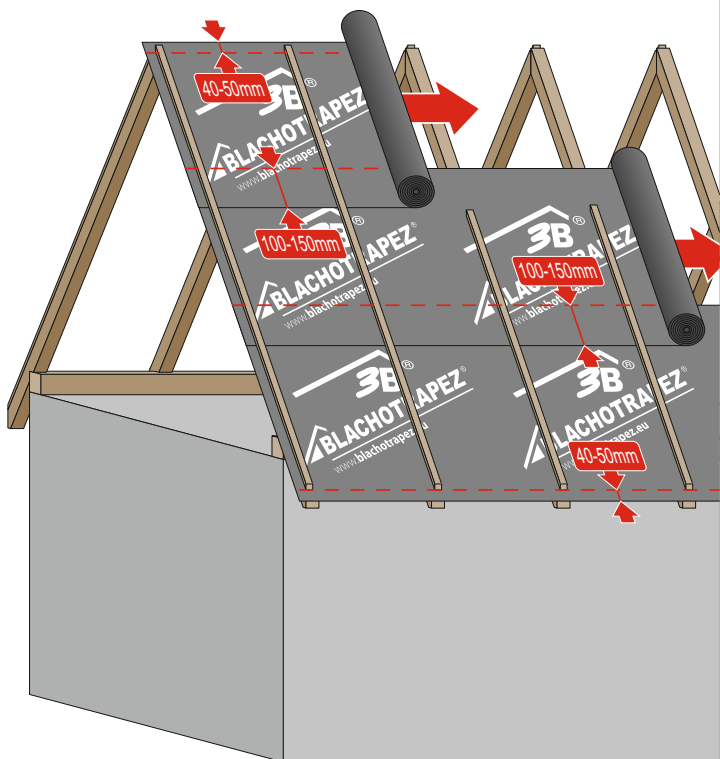

3b

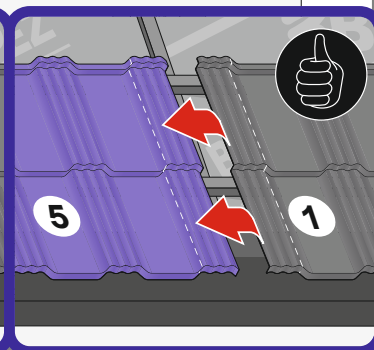
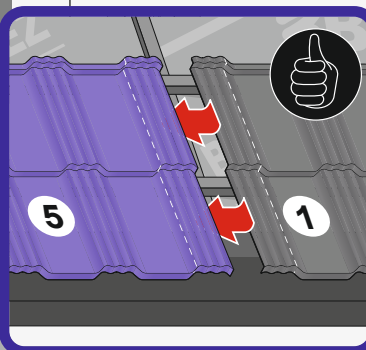
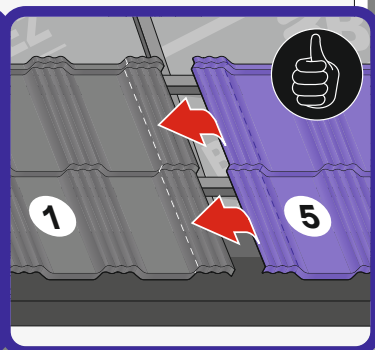
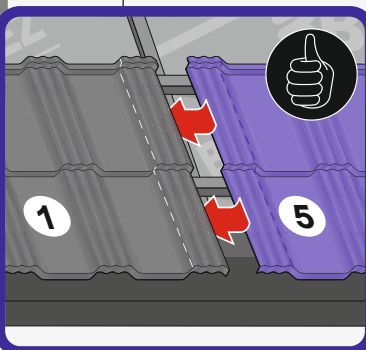
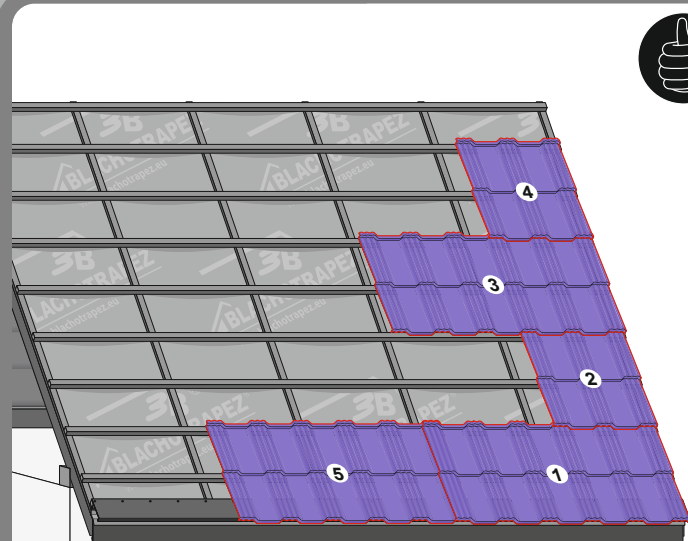
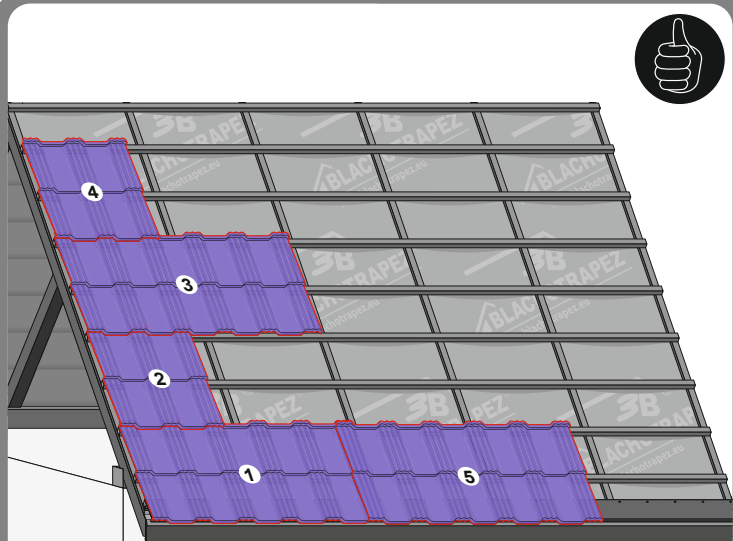
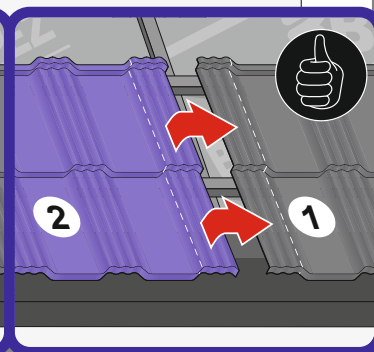
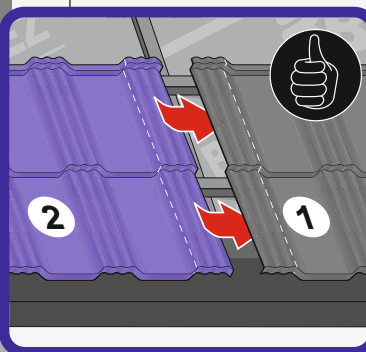
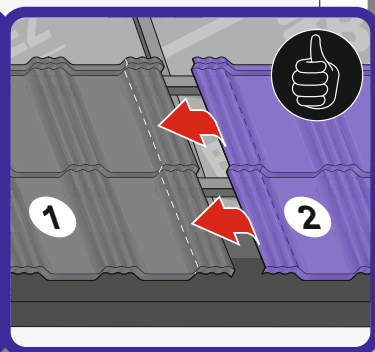
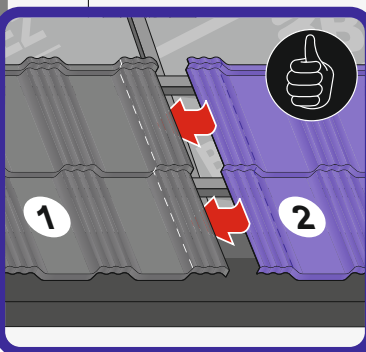
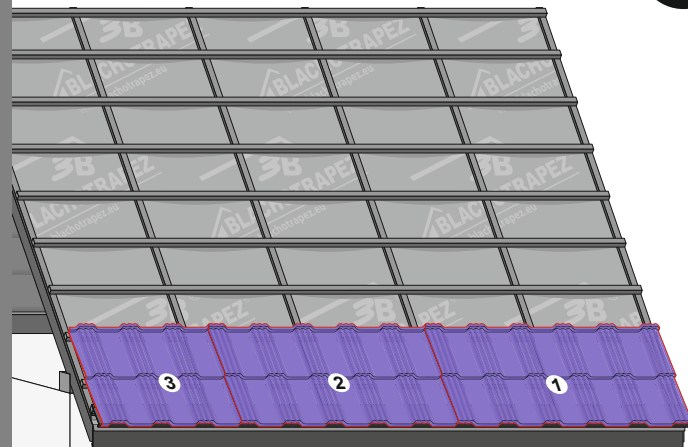
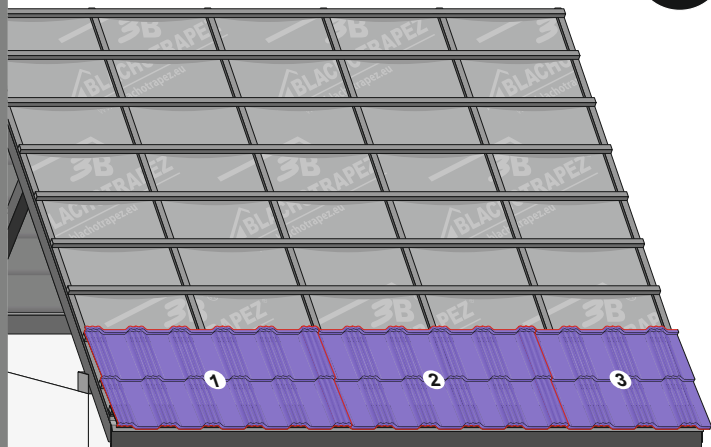

3c

Germania[®]
simetric

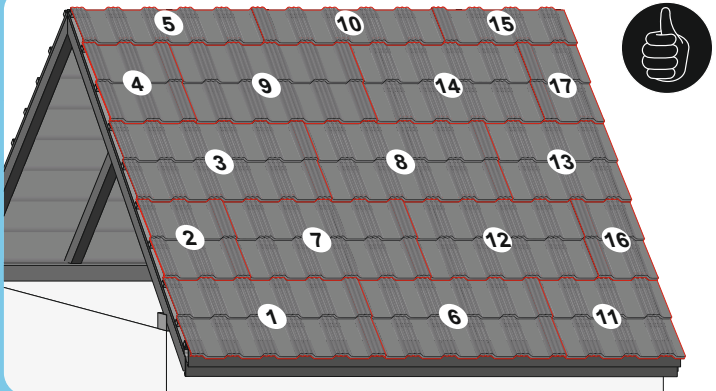
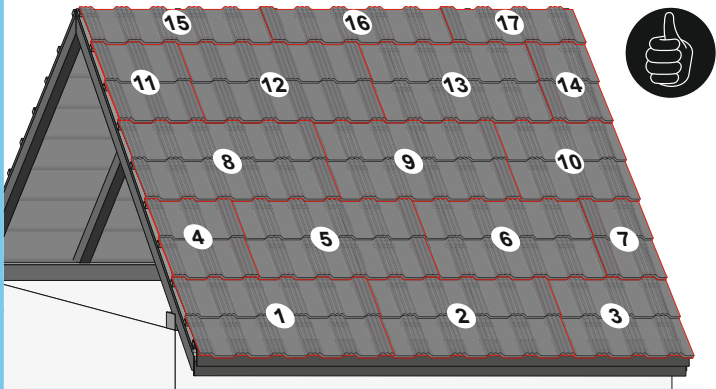

3d

GERMAN
simetric

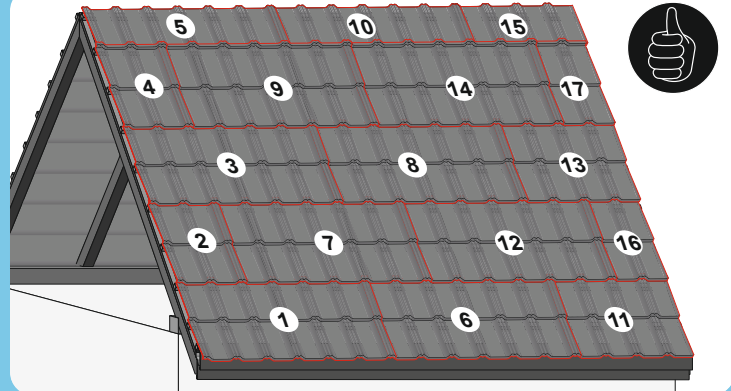
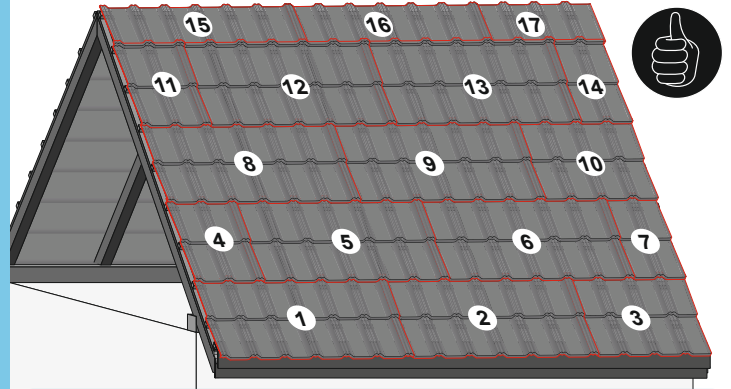

3e

TANIA

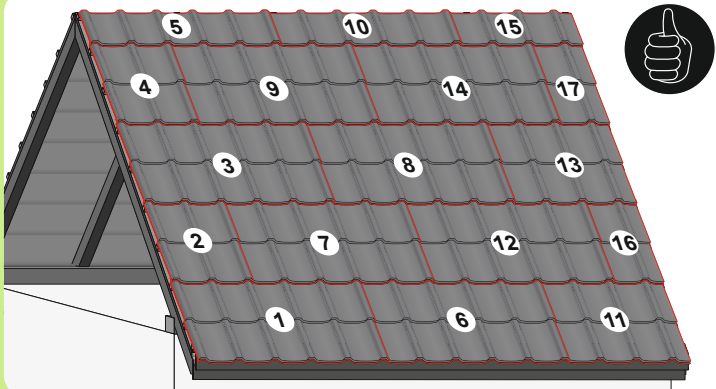
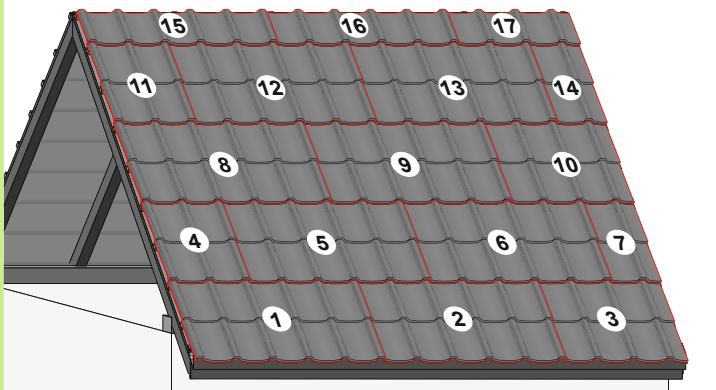

3f

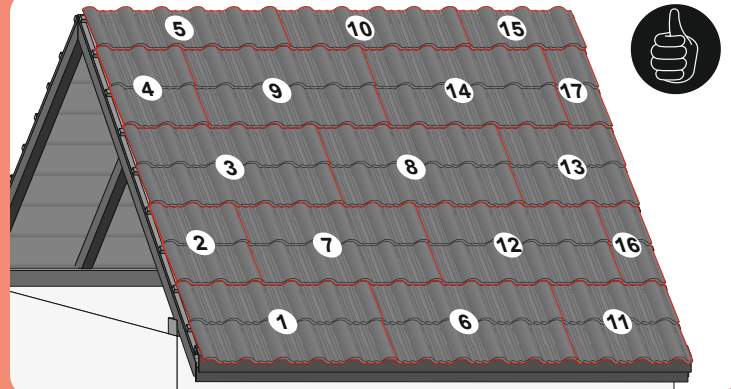
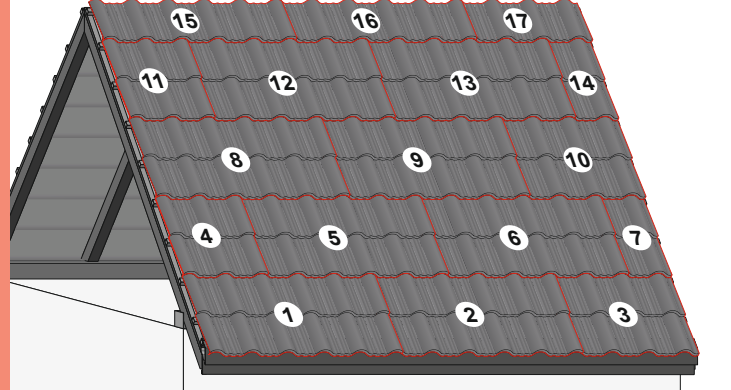

ENIGMA

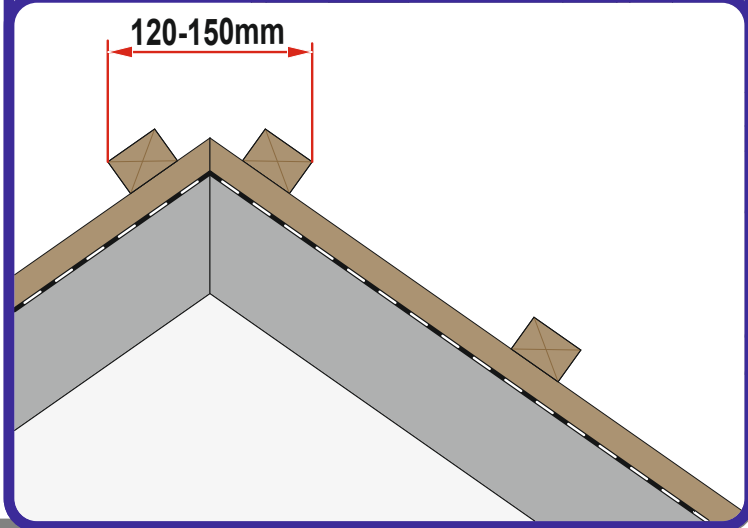
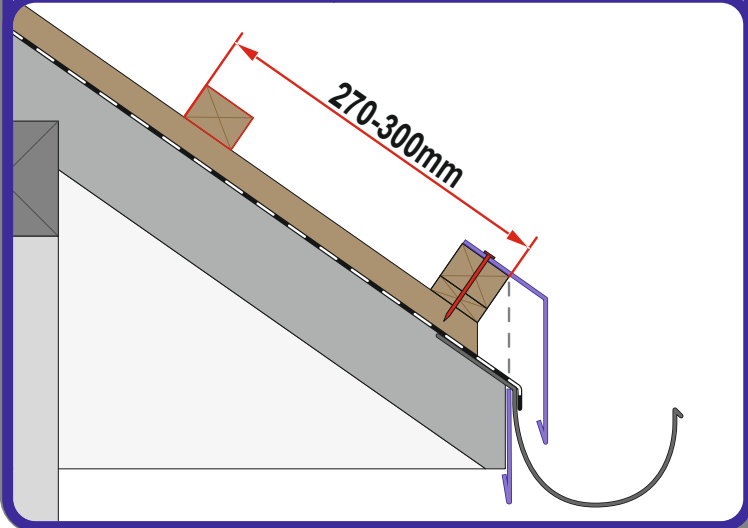
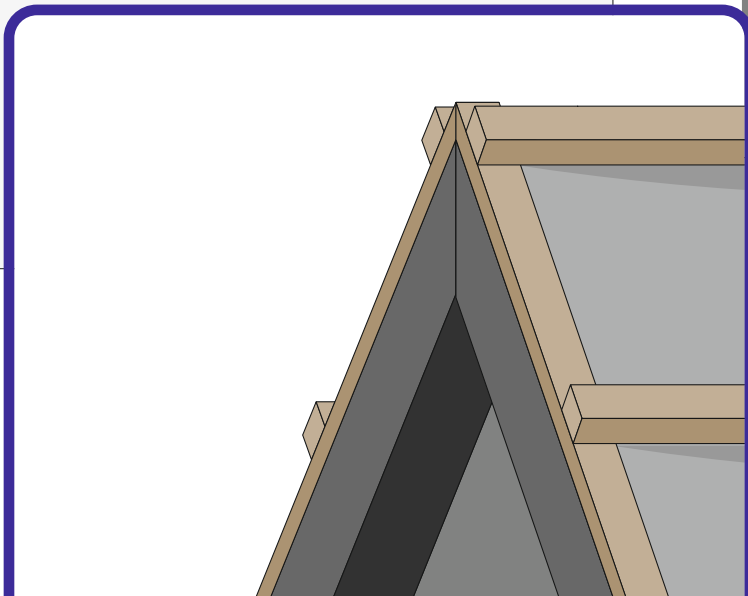
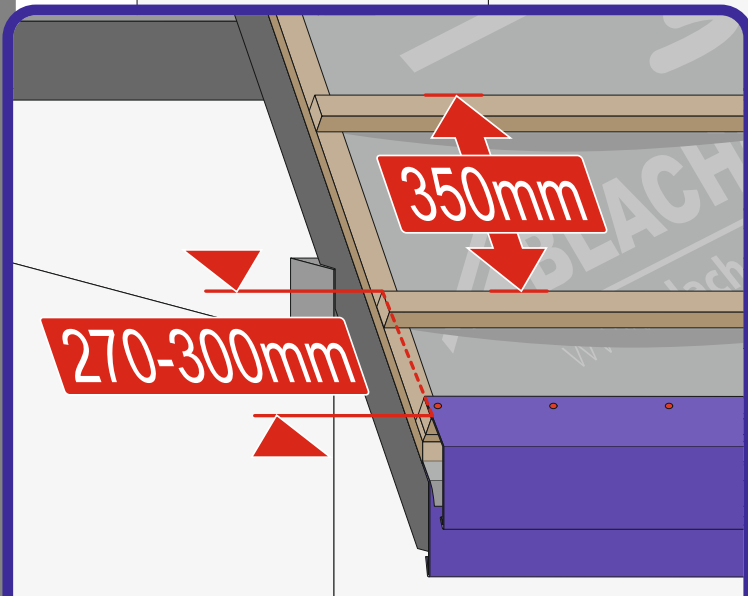
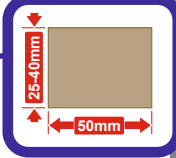
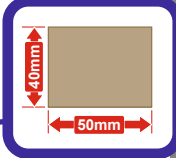
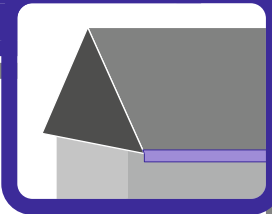

4

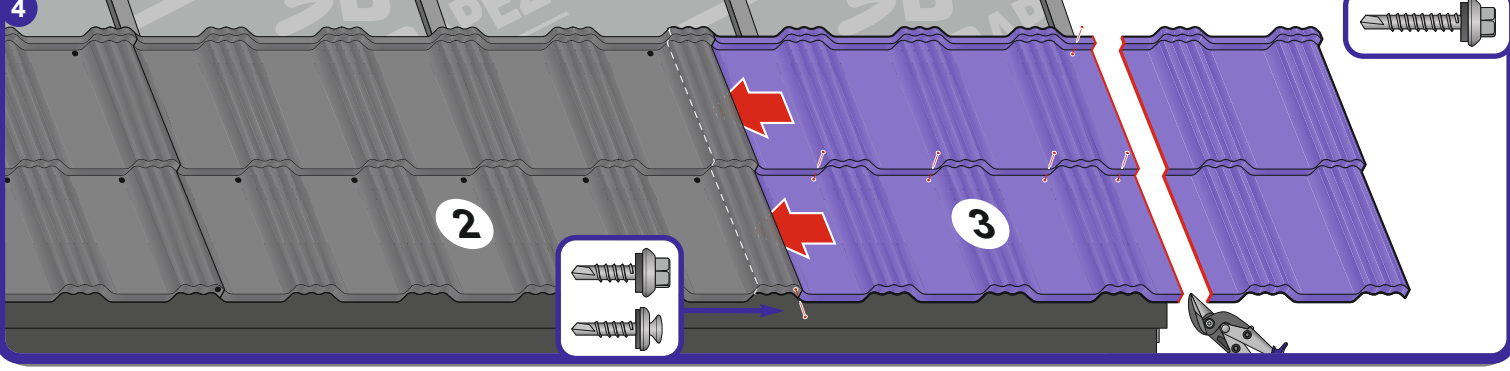
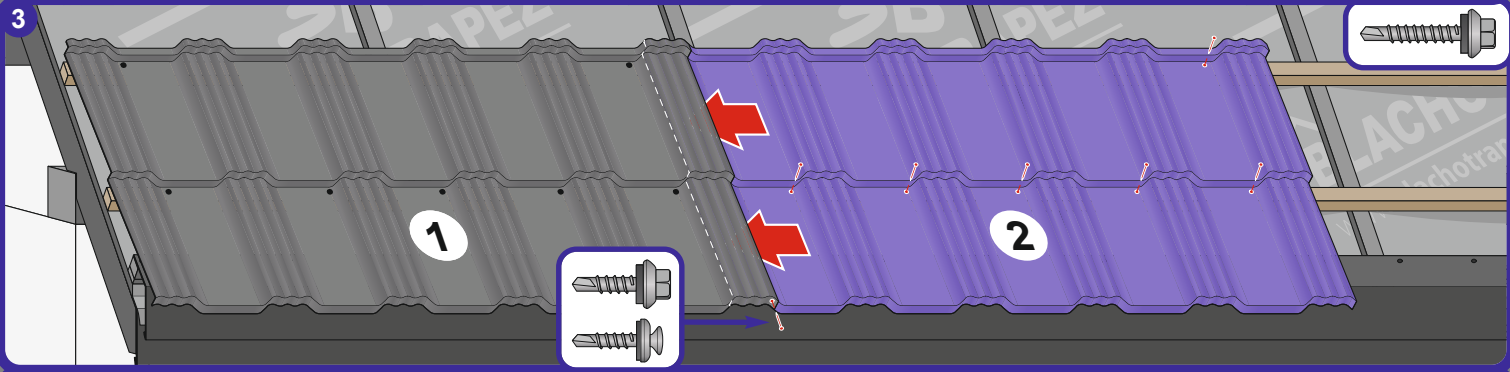
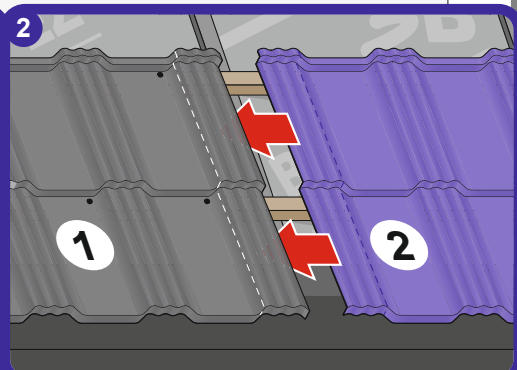
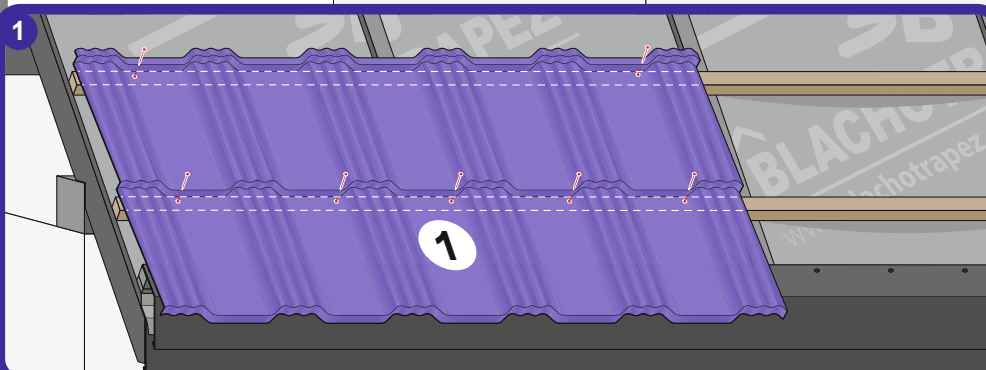
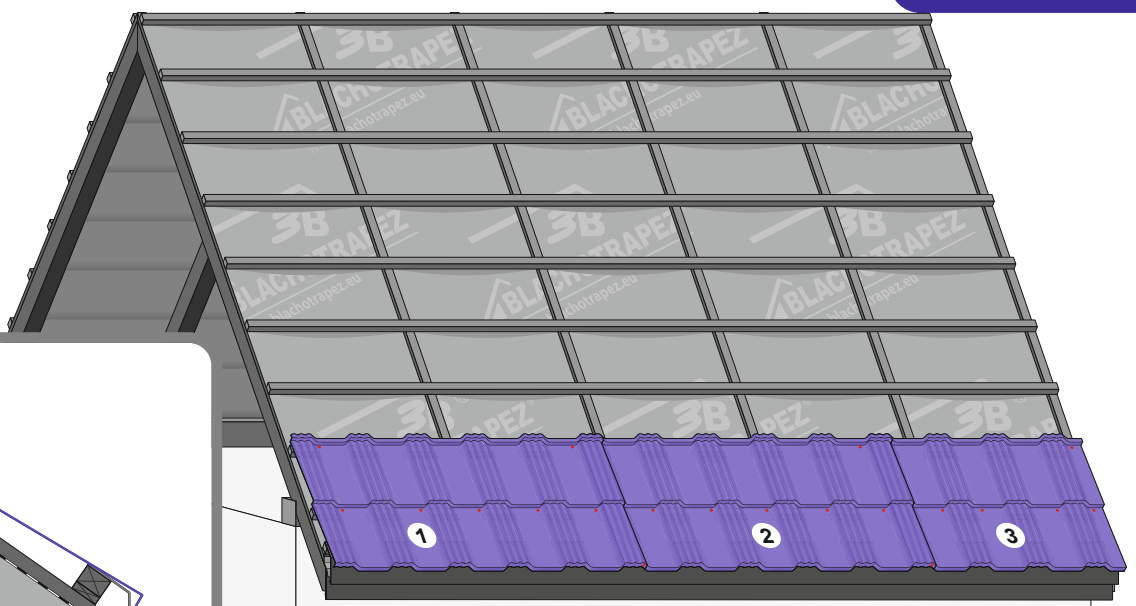
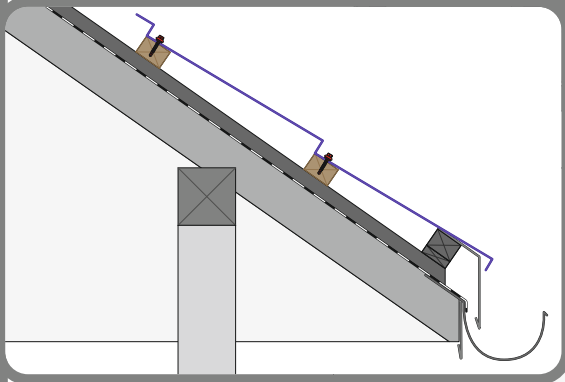
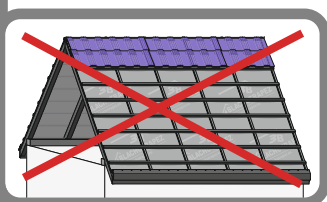
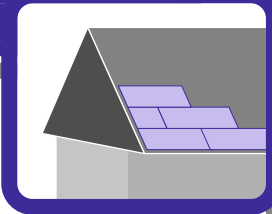

5a



5b

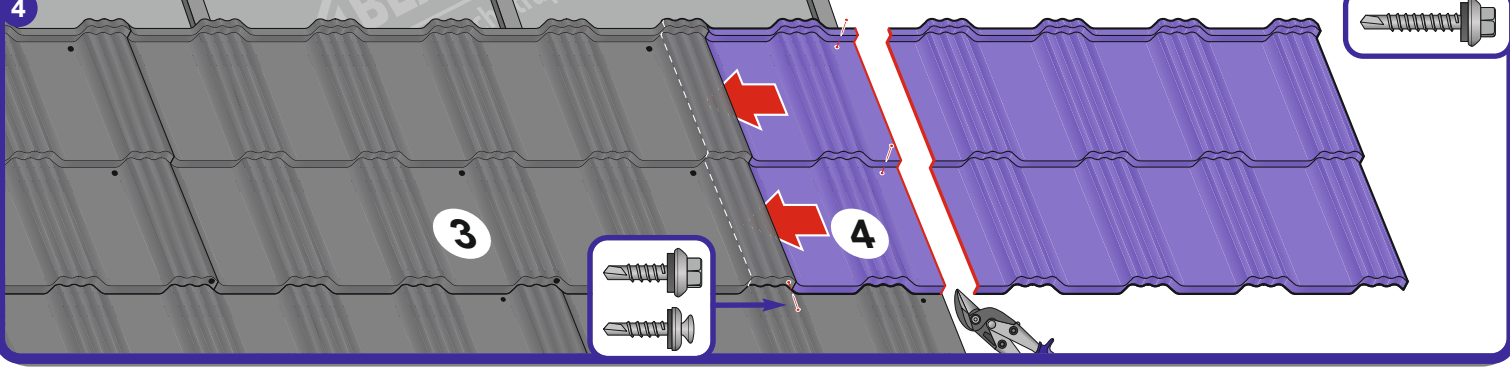
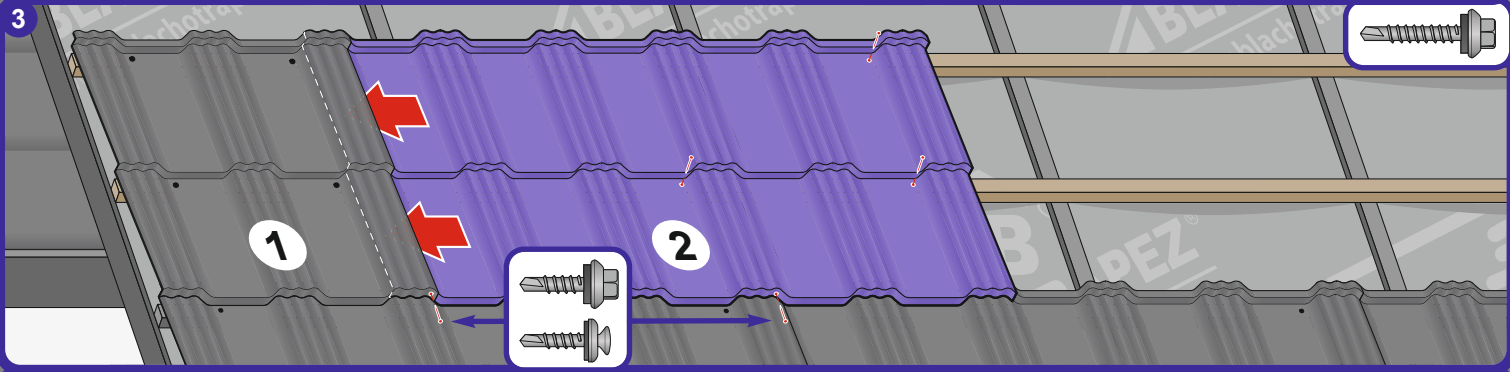
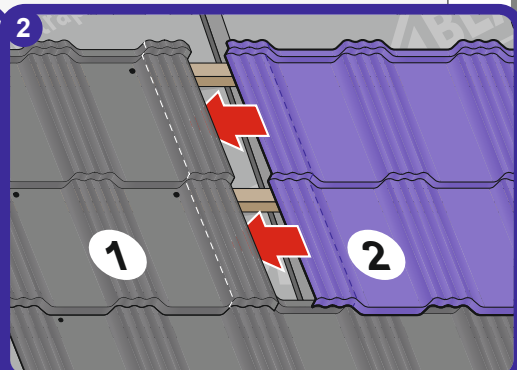
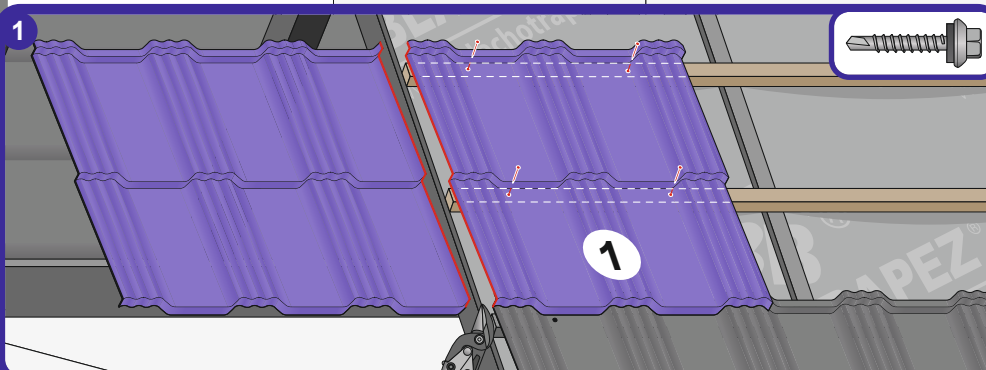
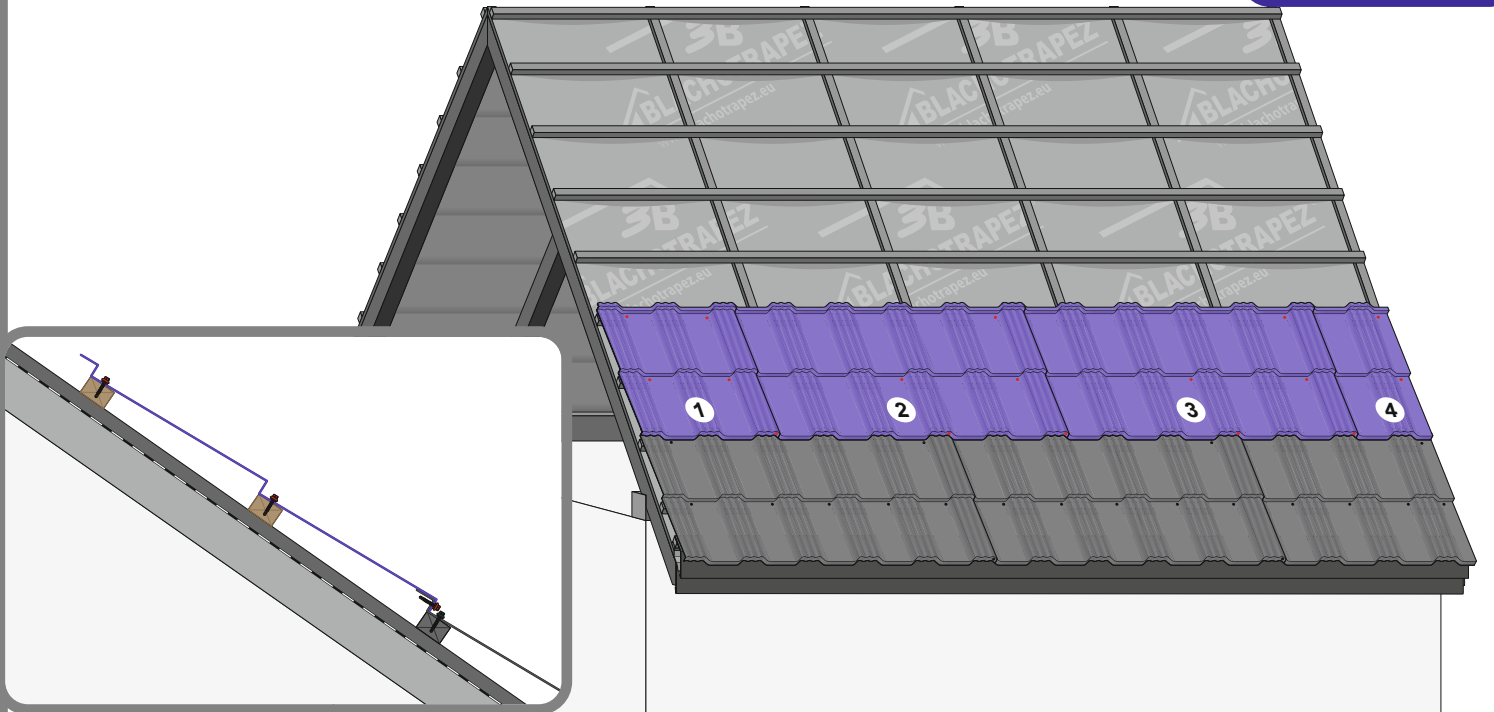
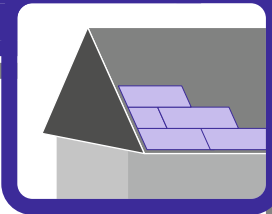

5c

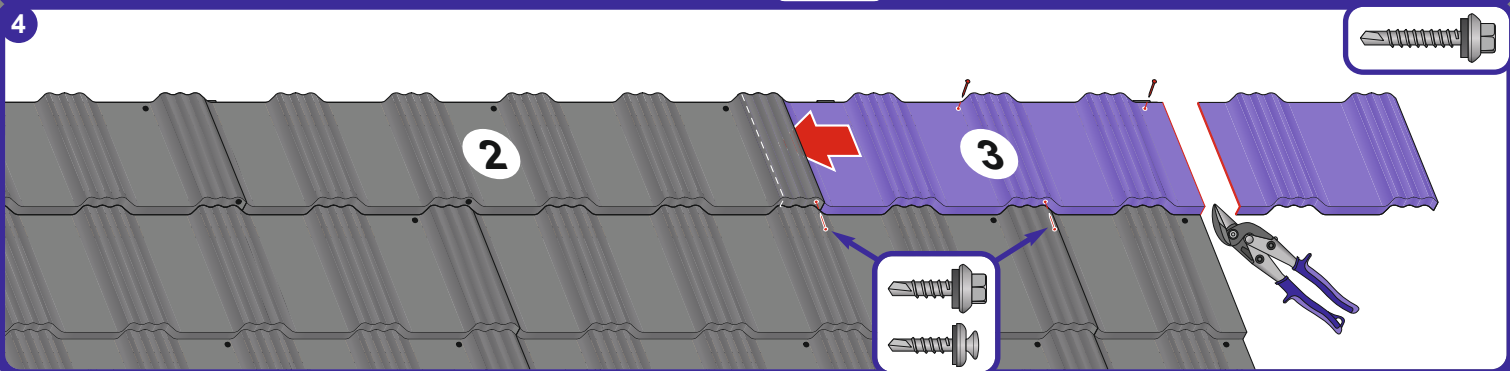
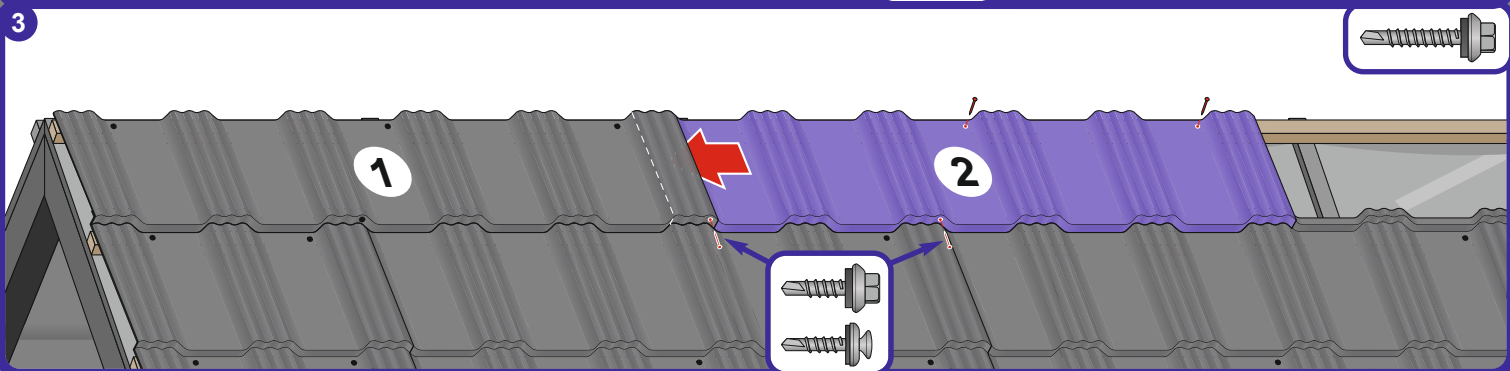
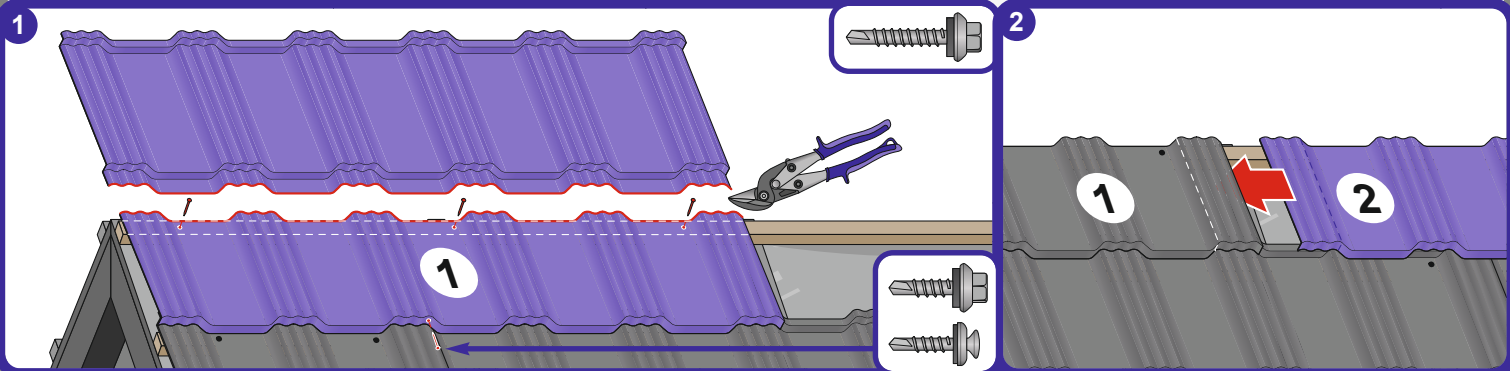
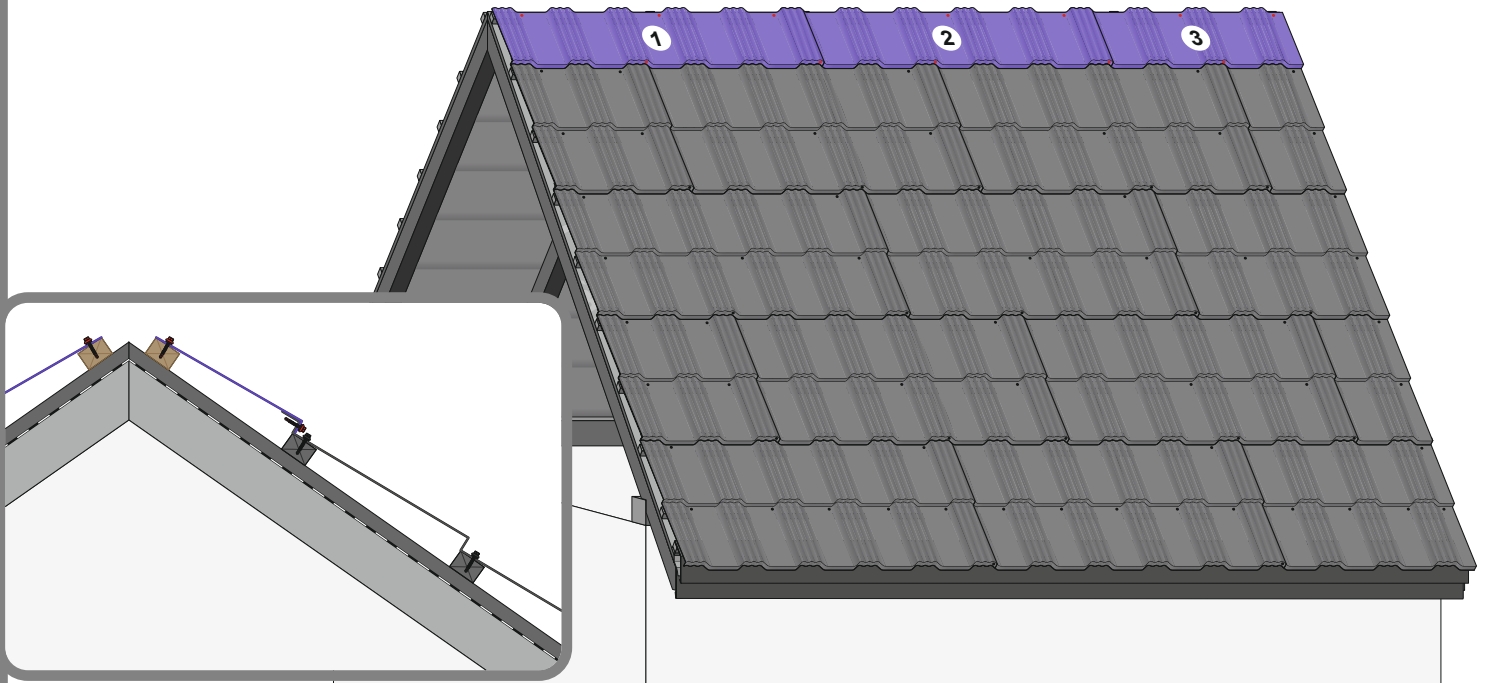
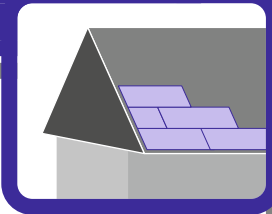

5d

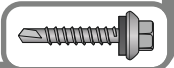
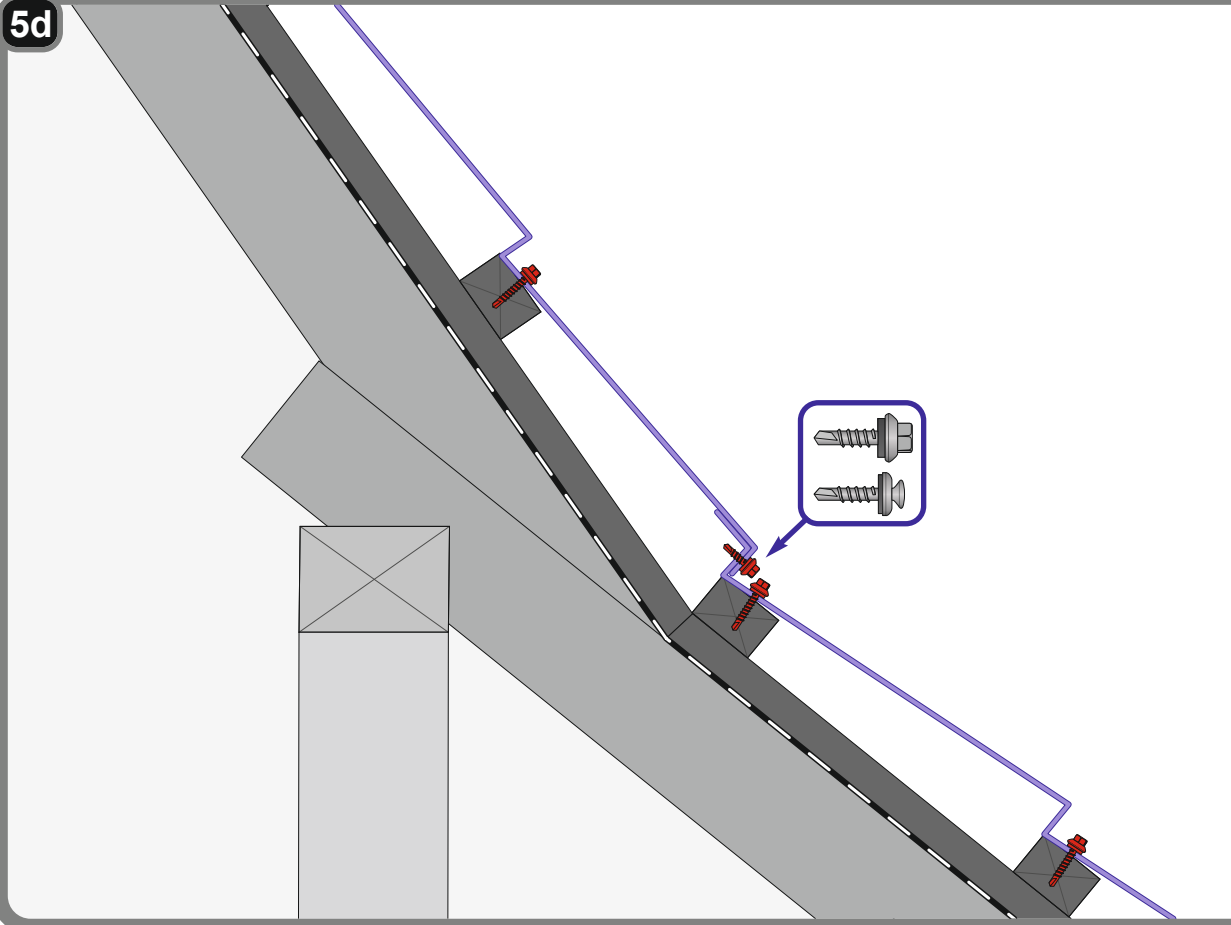
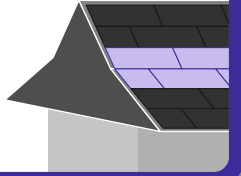

5e

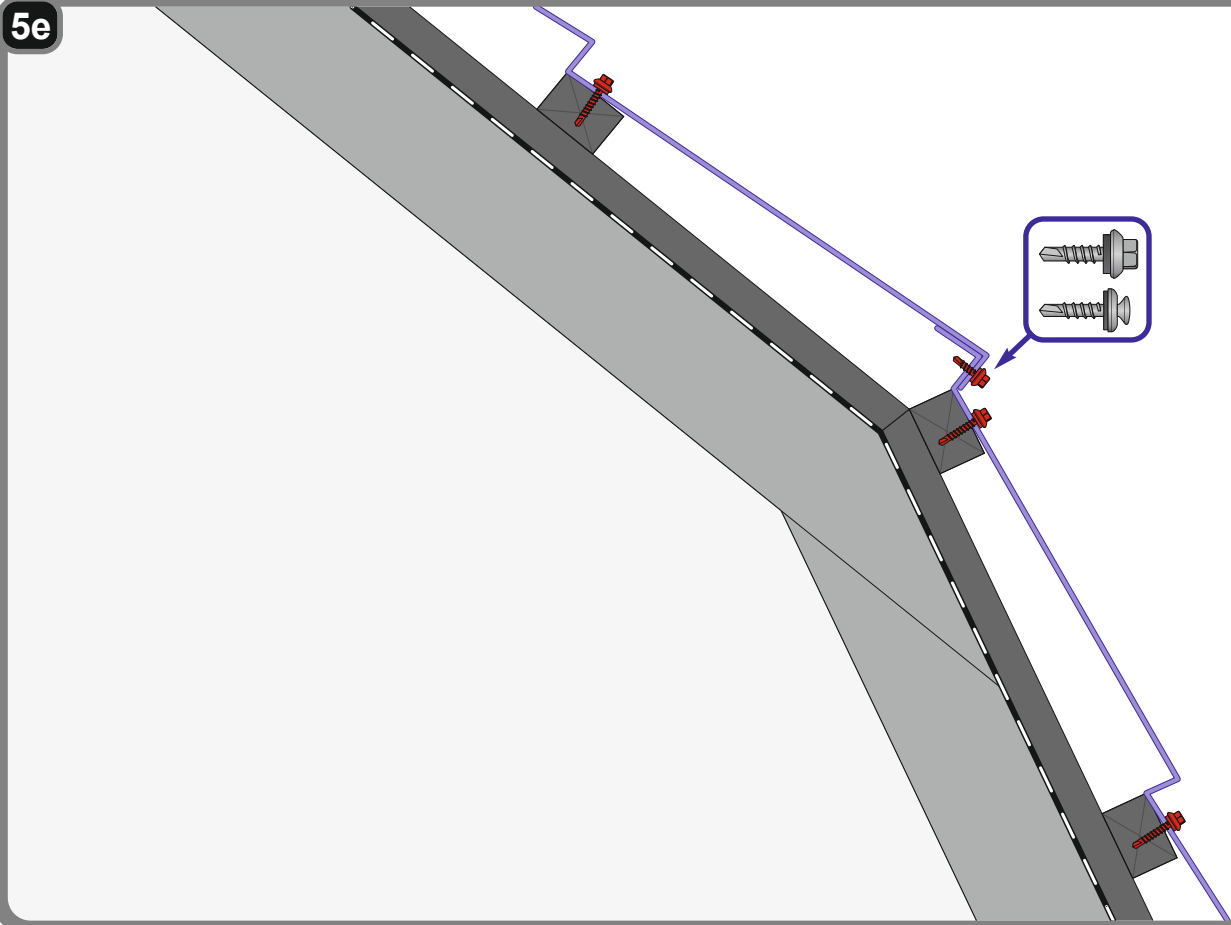
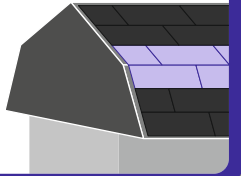

6a

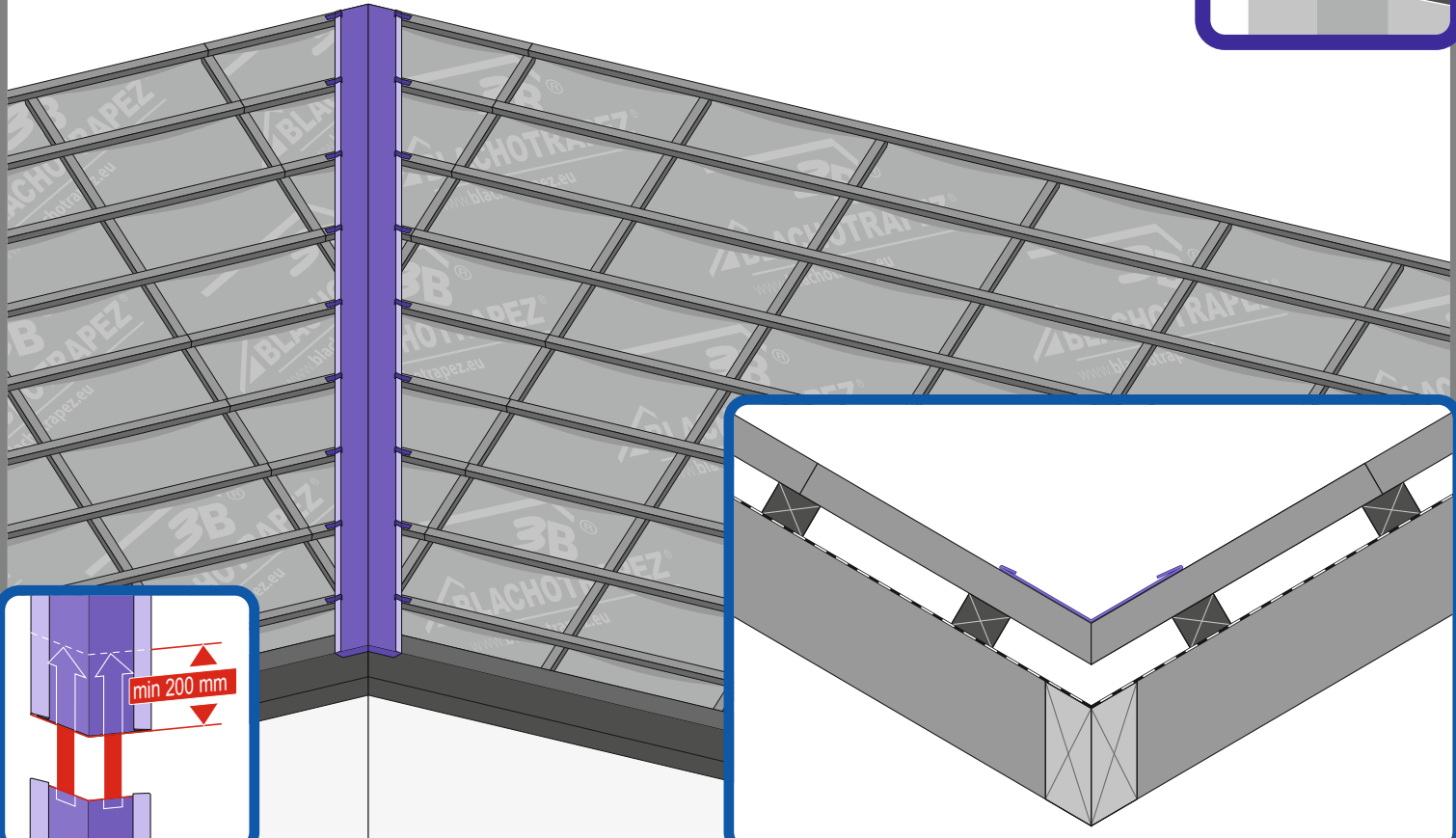
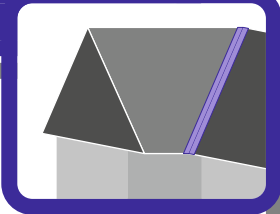

min 200 mm

6b

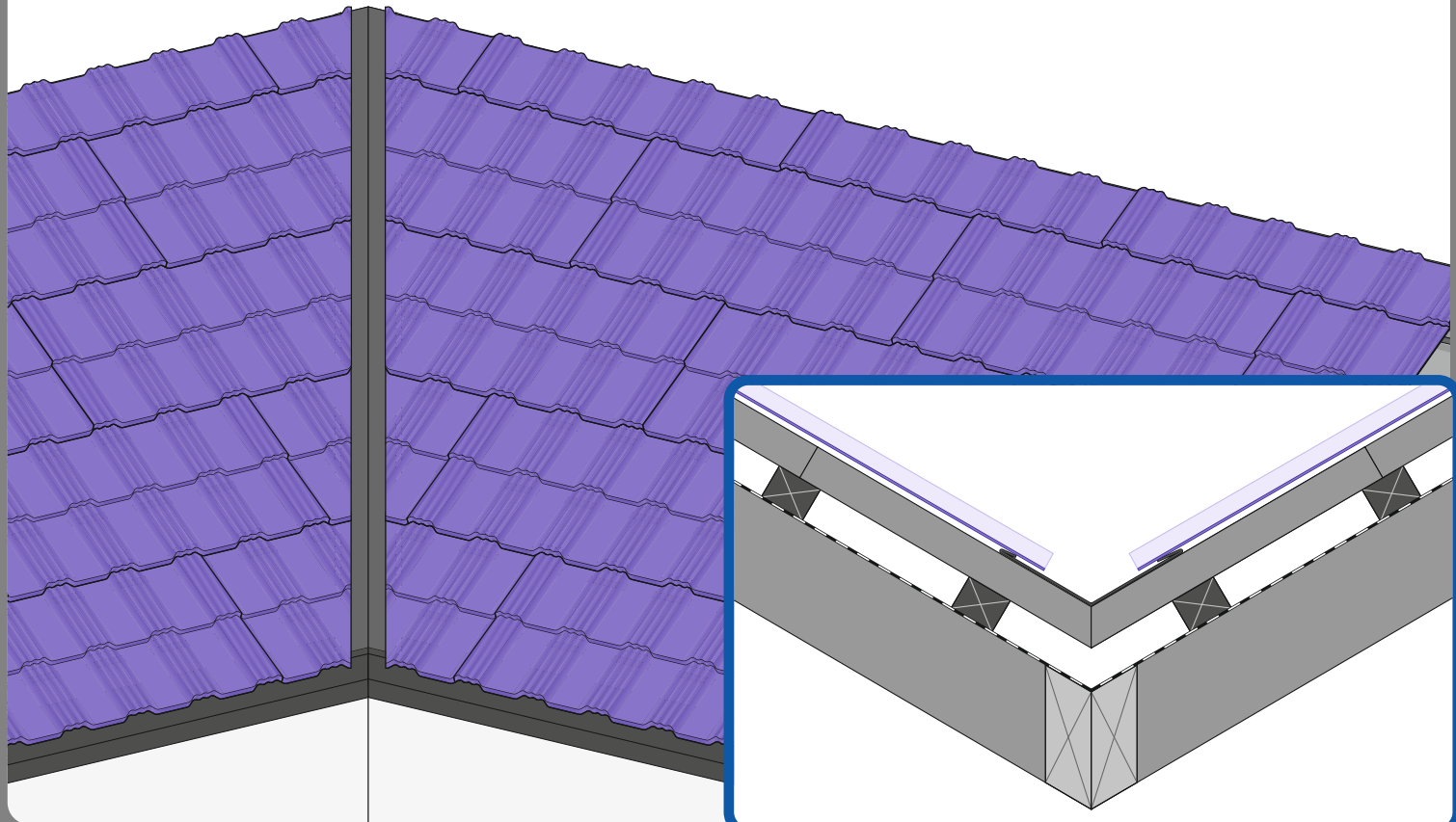

Germania[®]
simetric

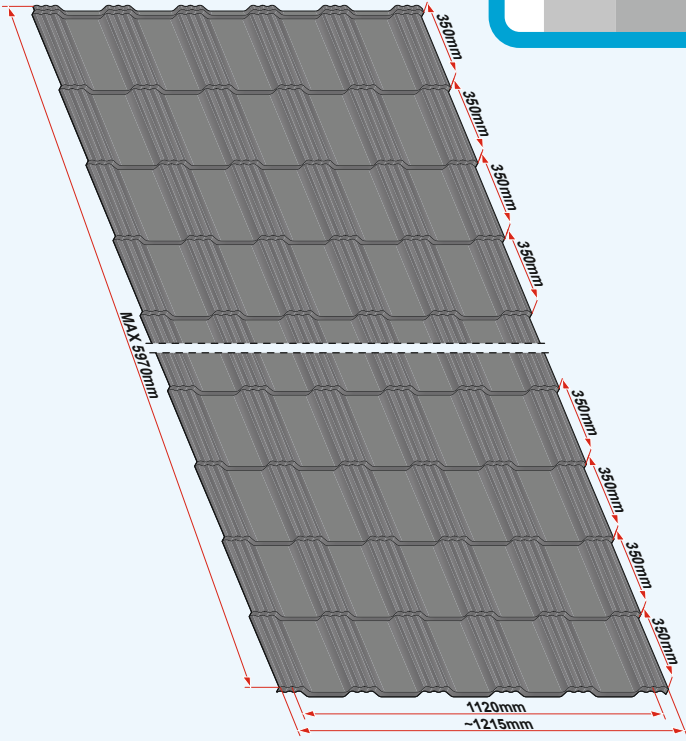
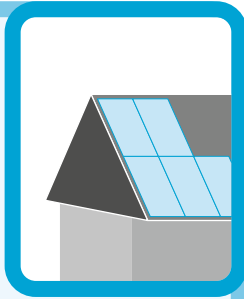

GERMAN
simetric

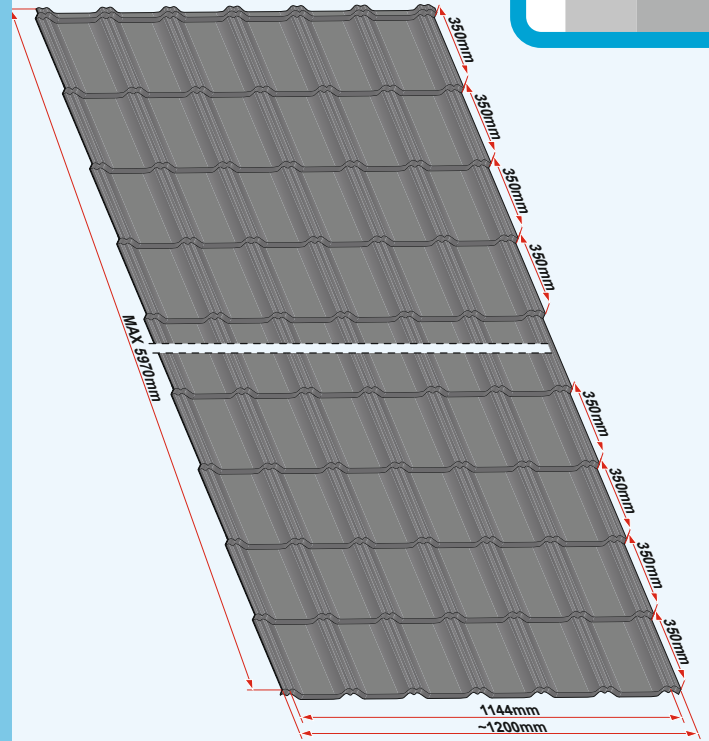
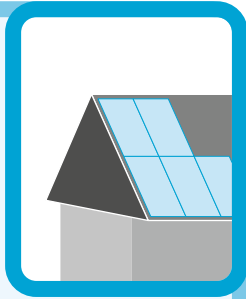

TANIA

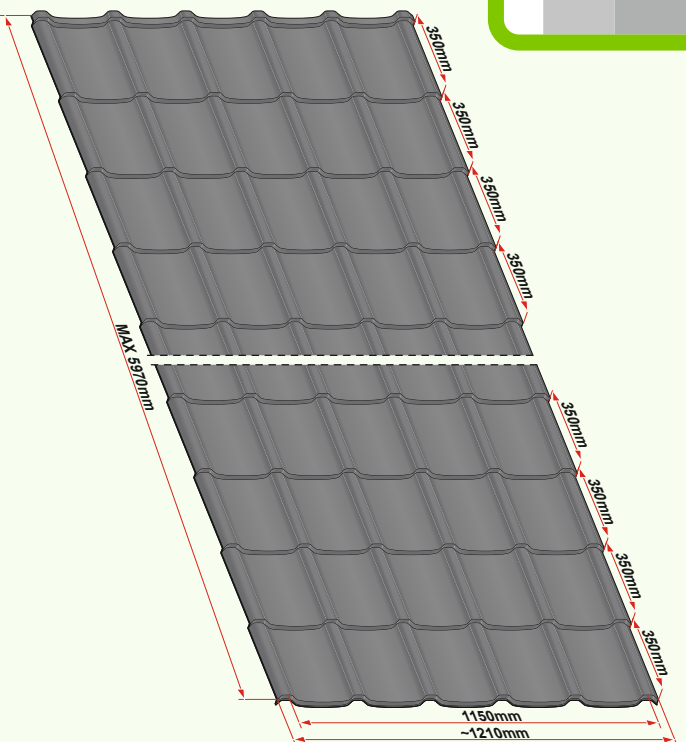
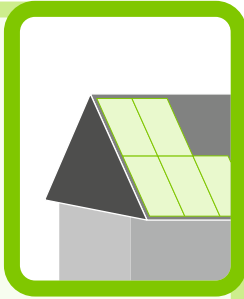

ENIGMA

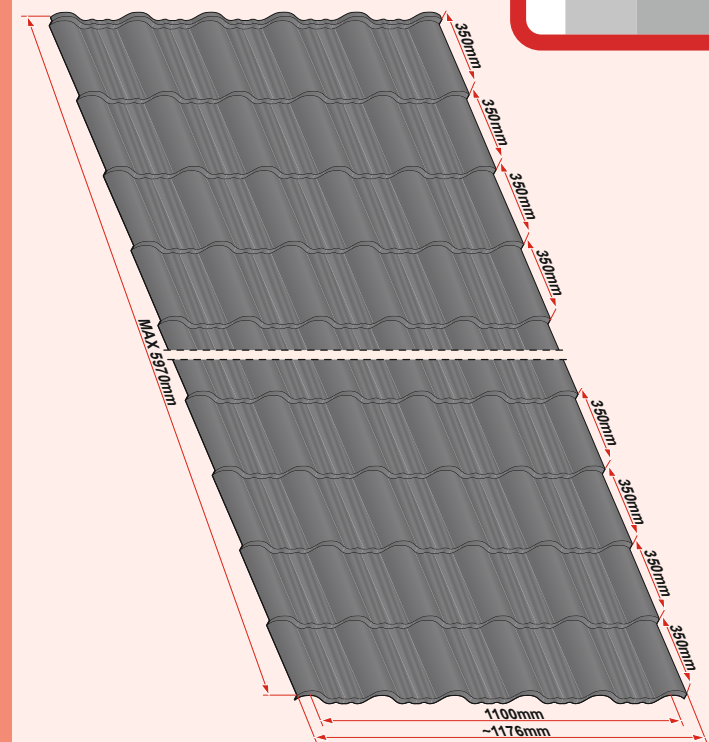
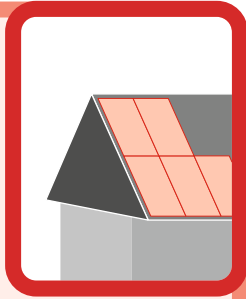

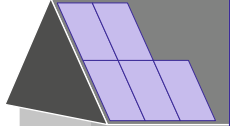

7a

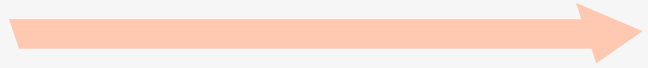
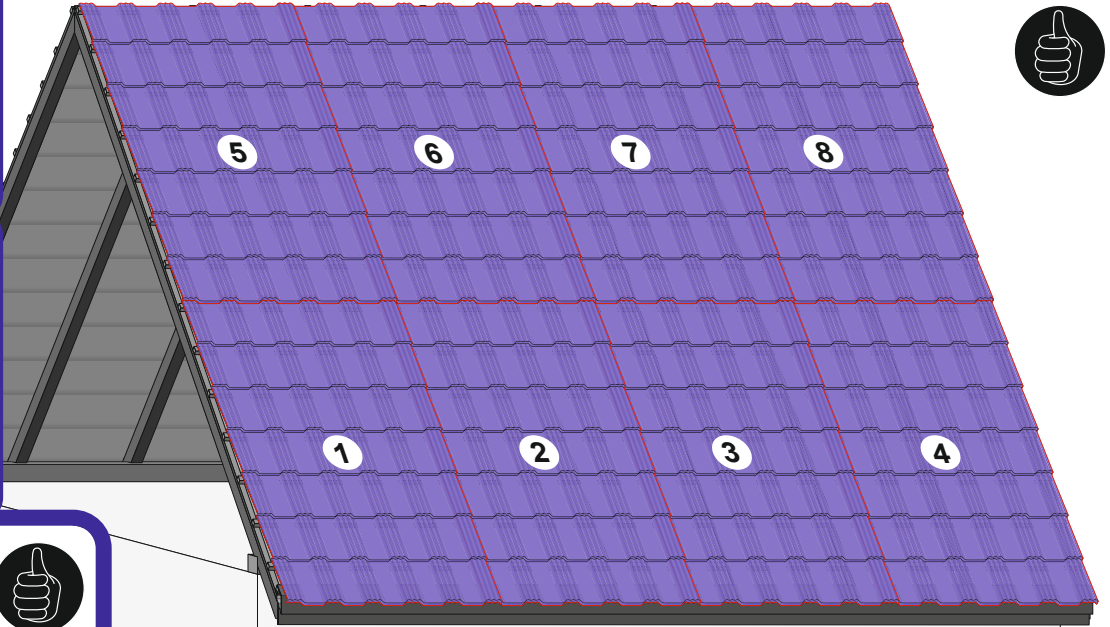
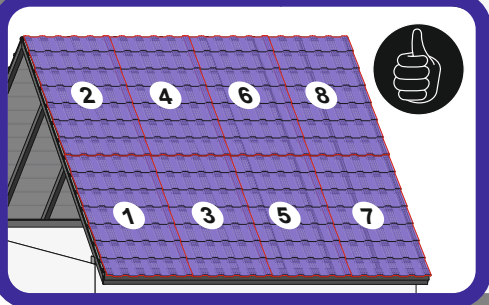
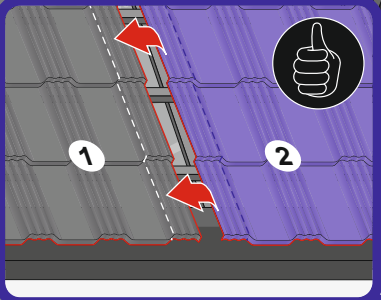
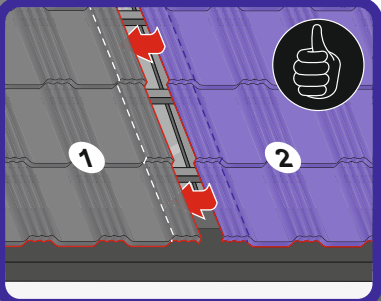

7b

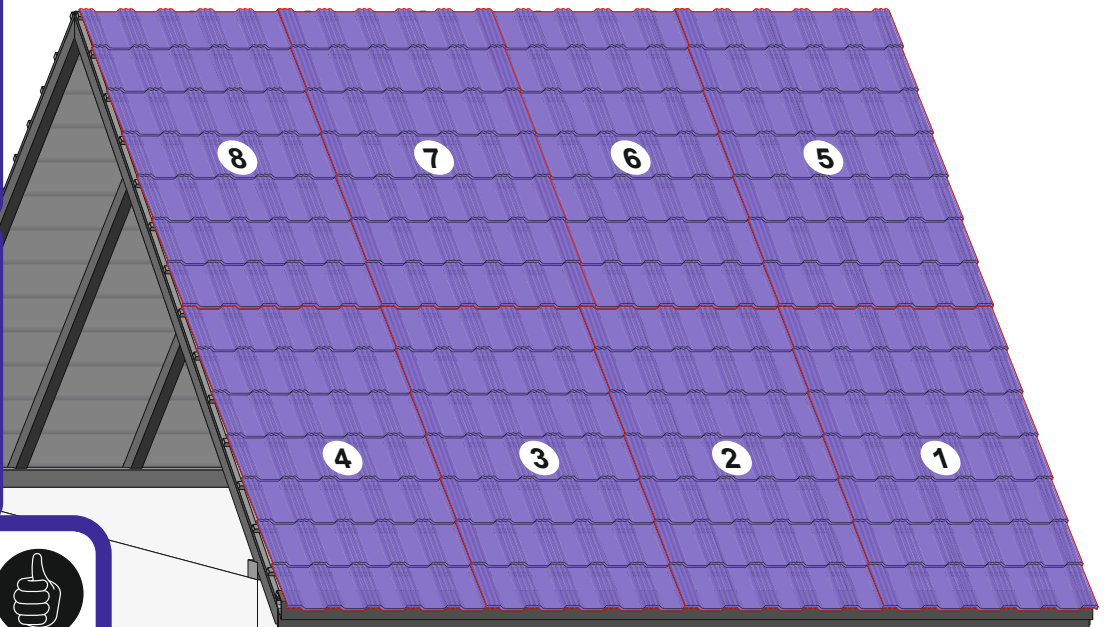
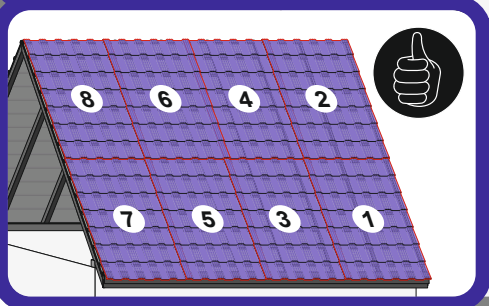
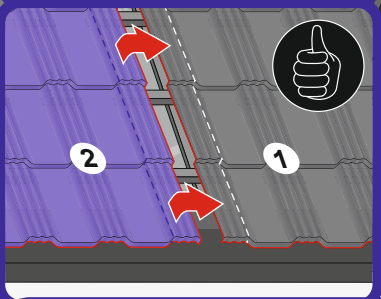
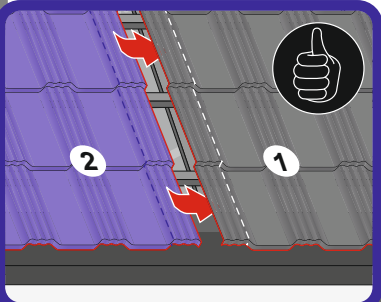

8a

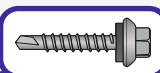
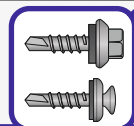
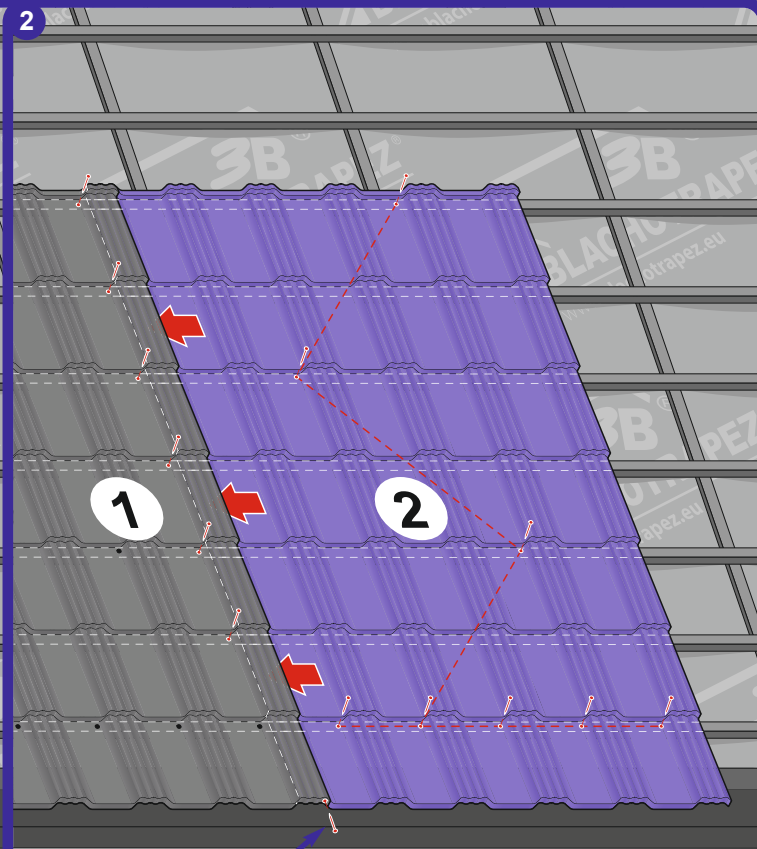
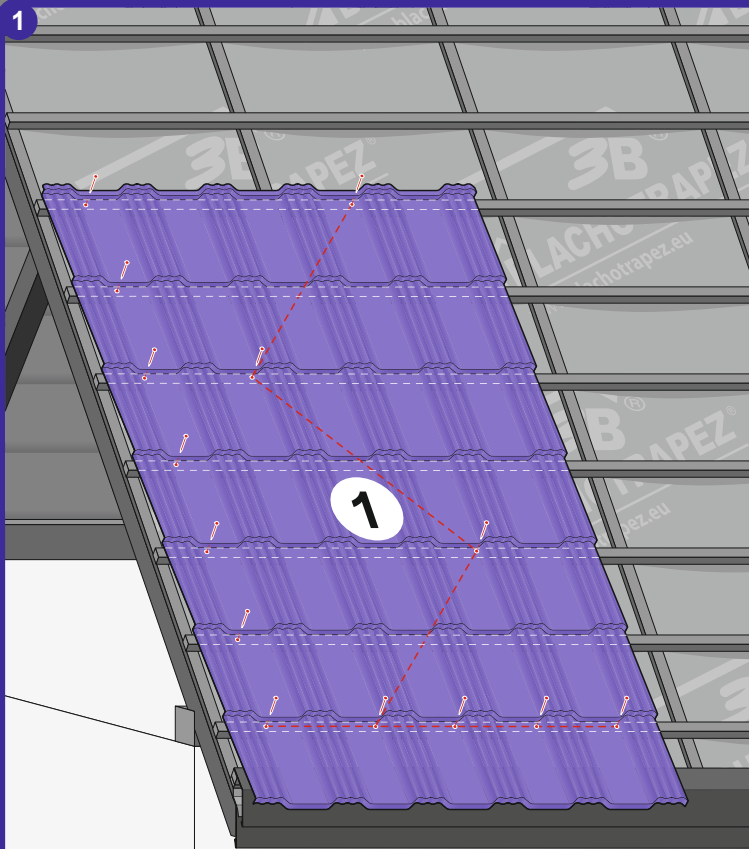
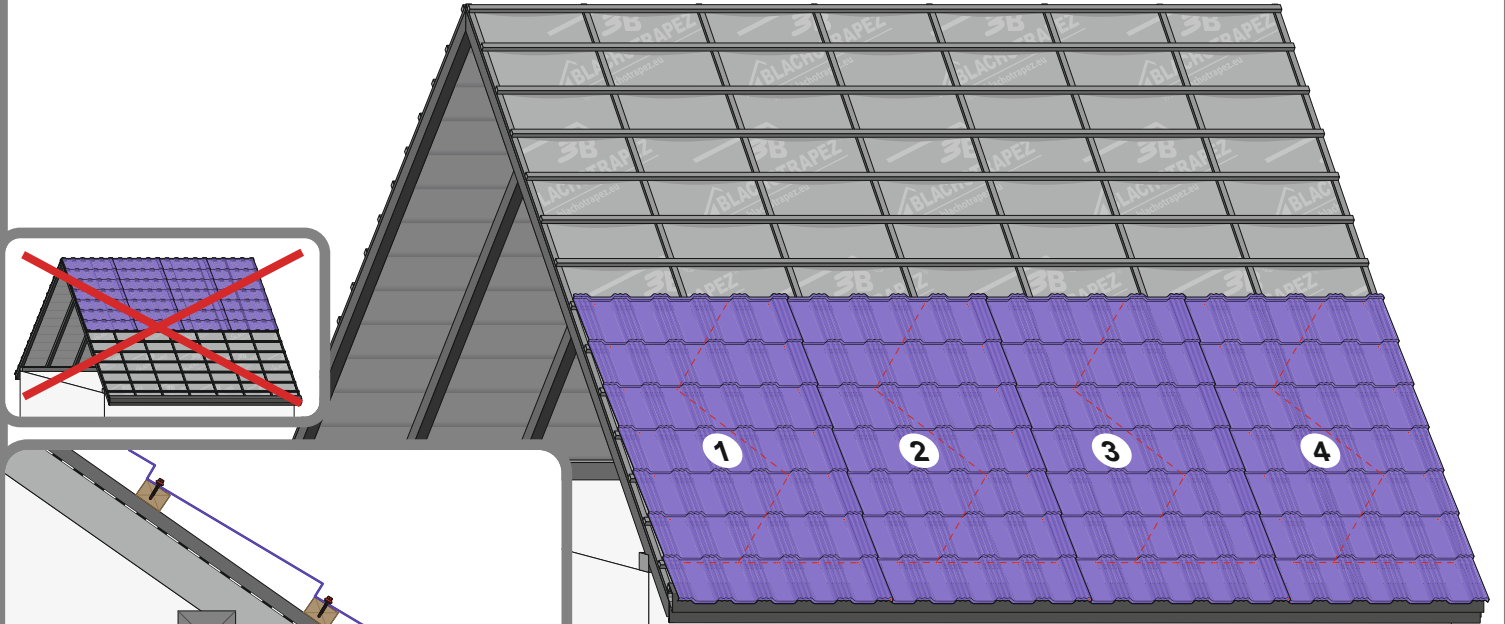
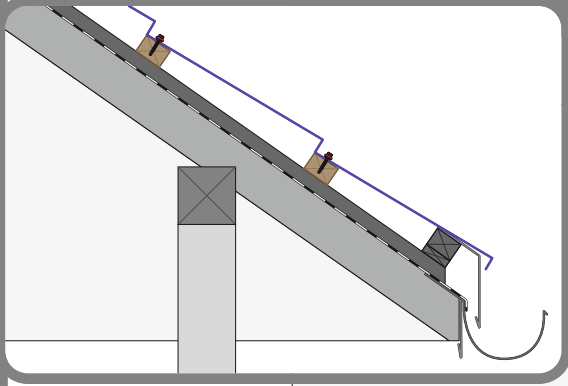
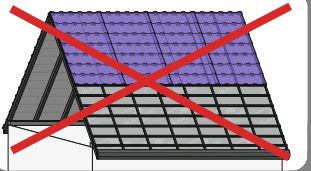
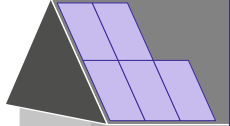

8b

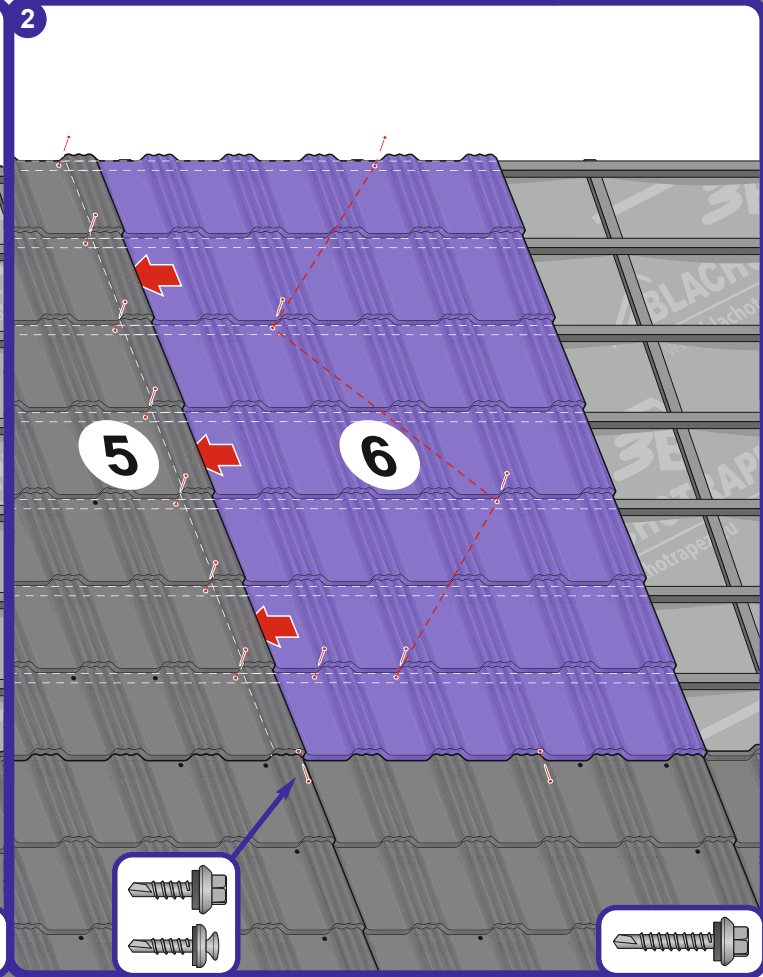
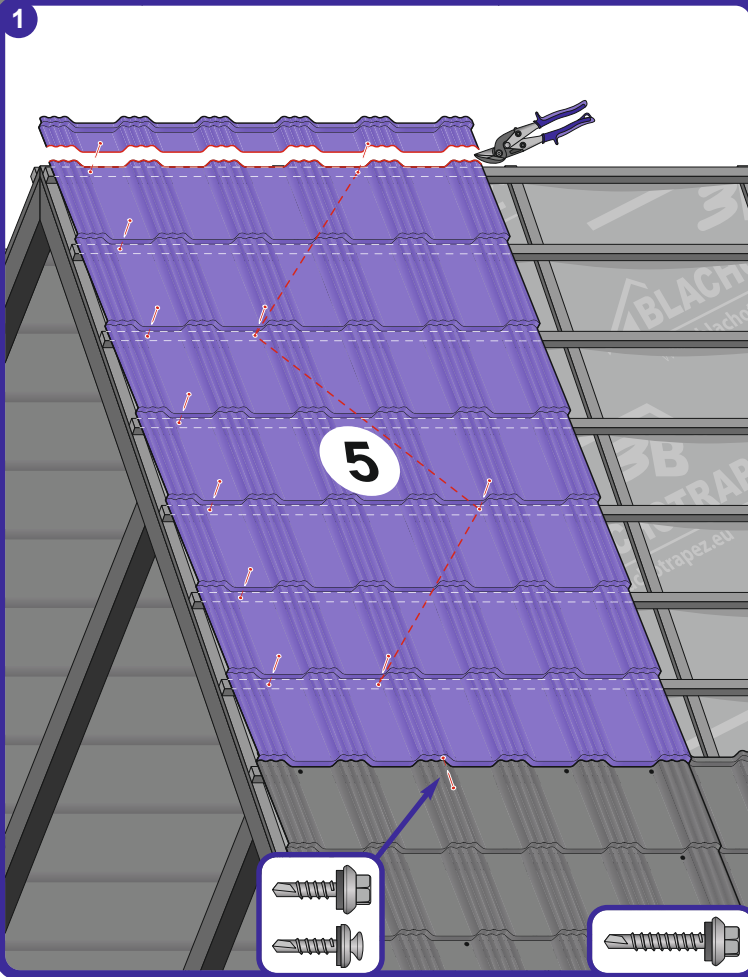
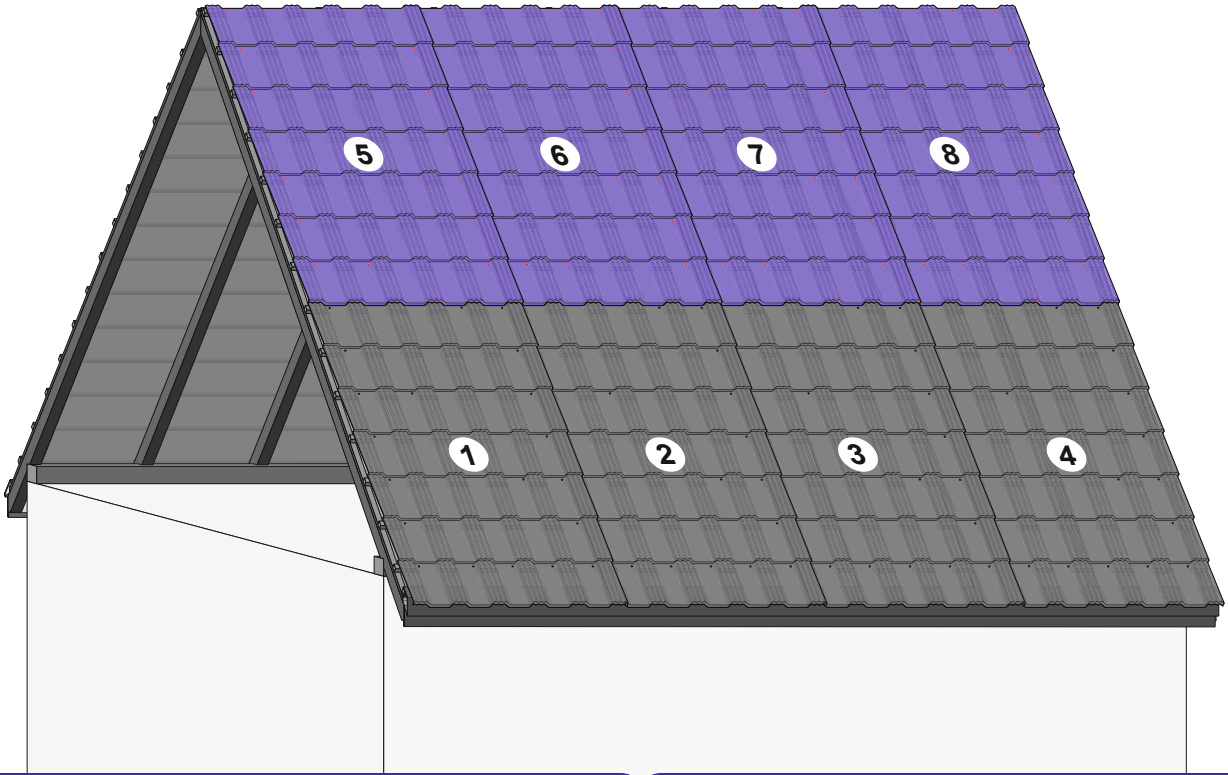
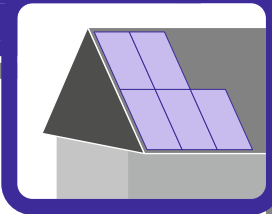

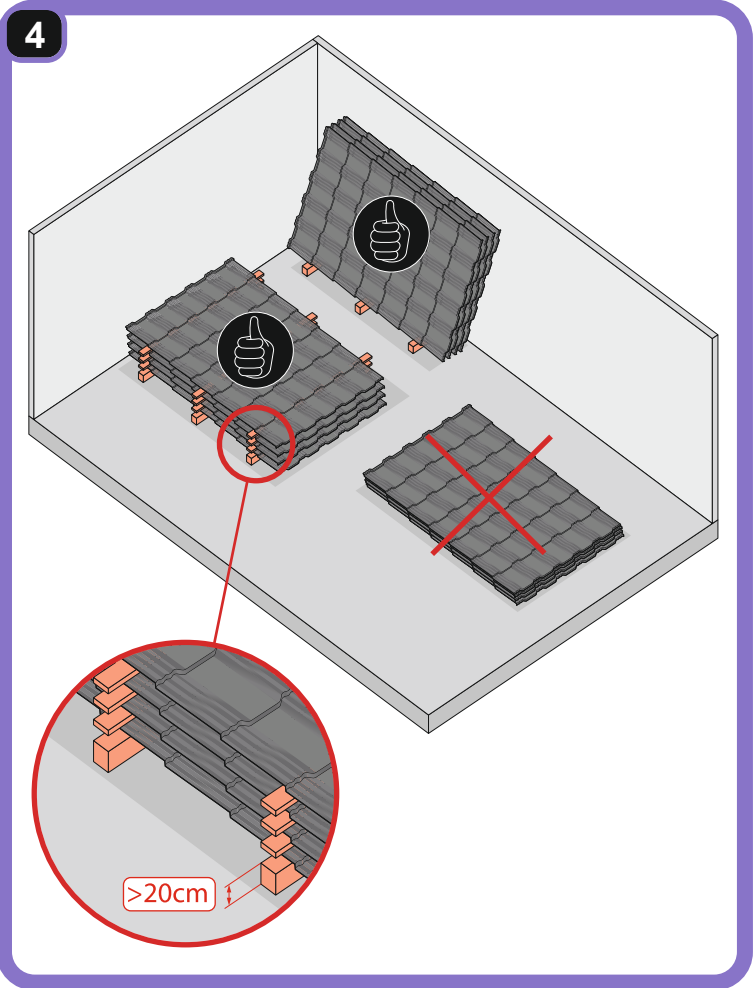
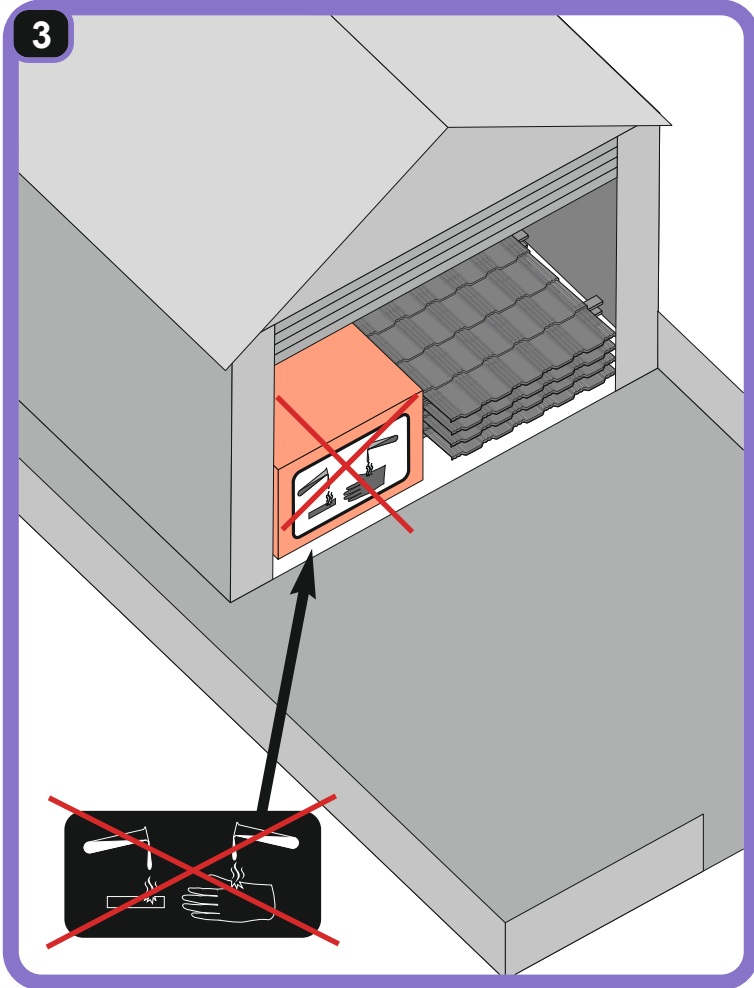
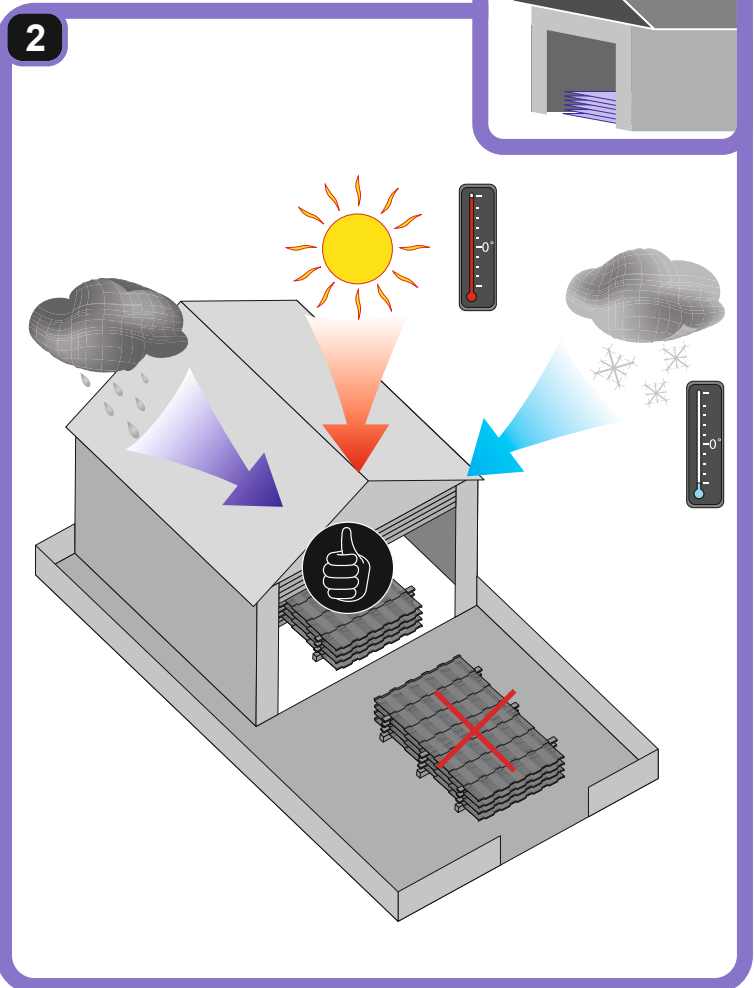
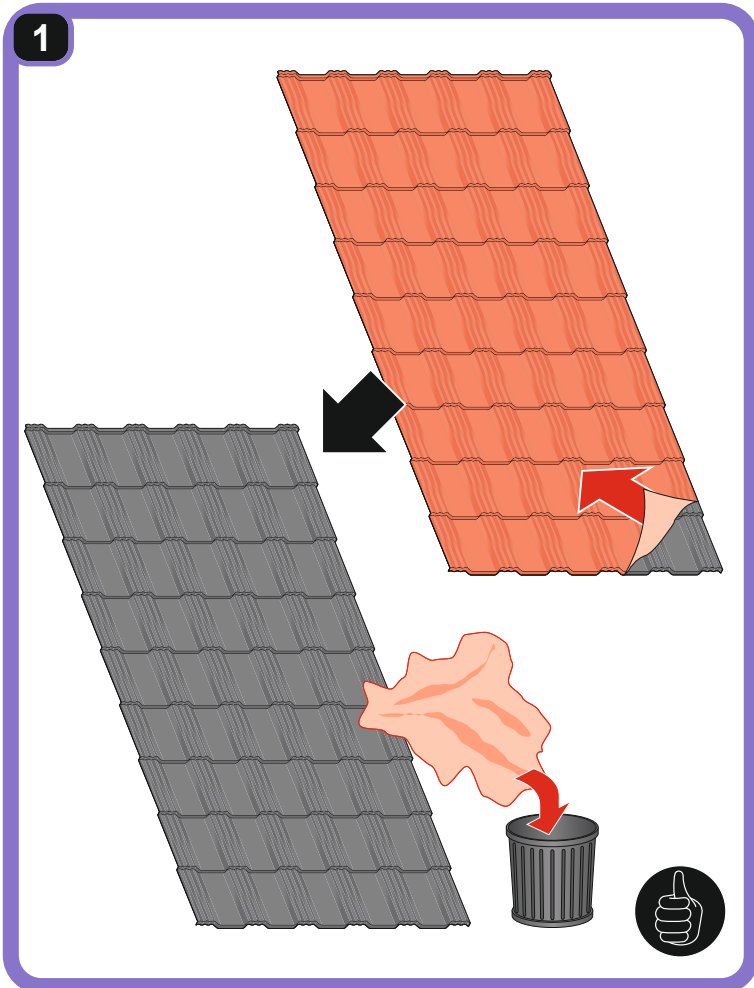

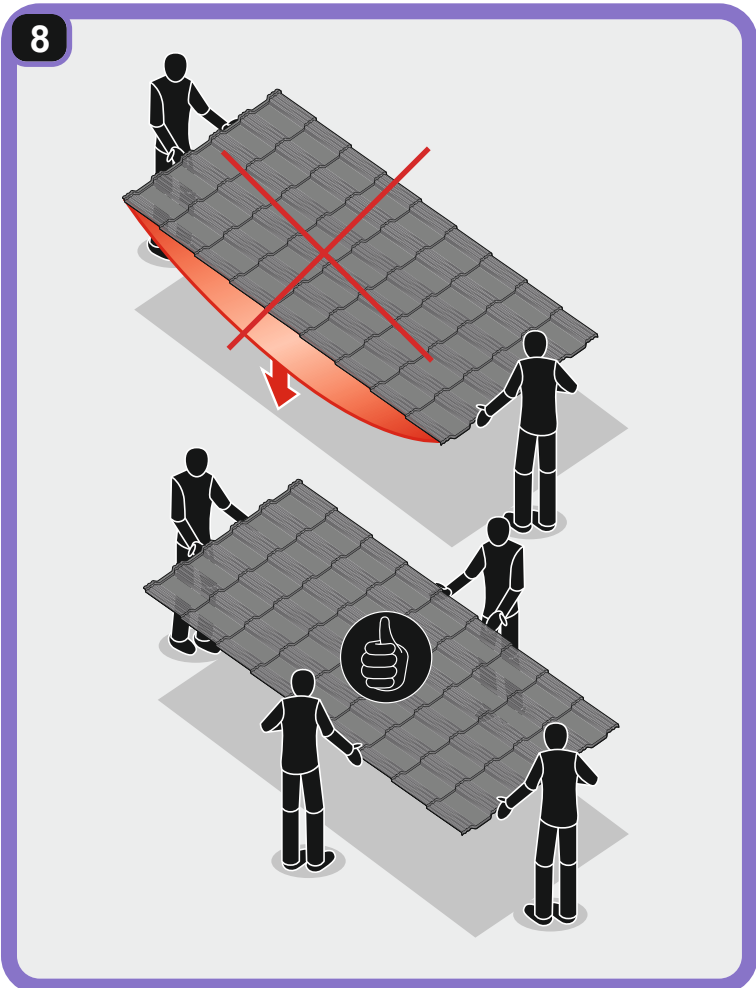
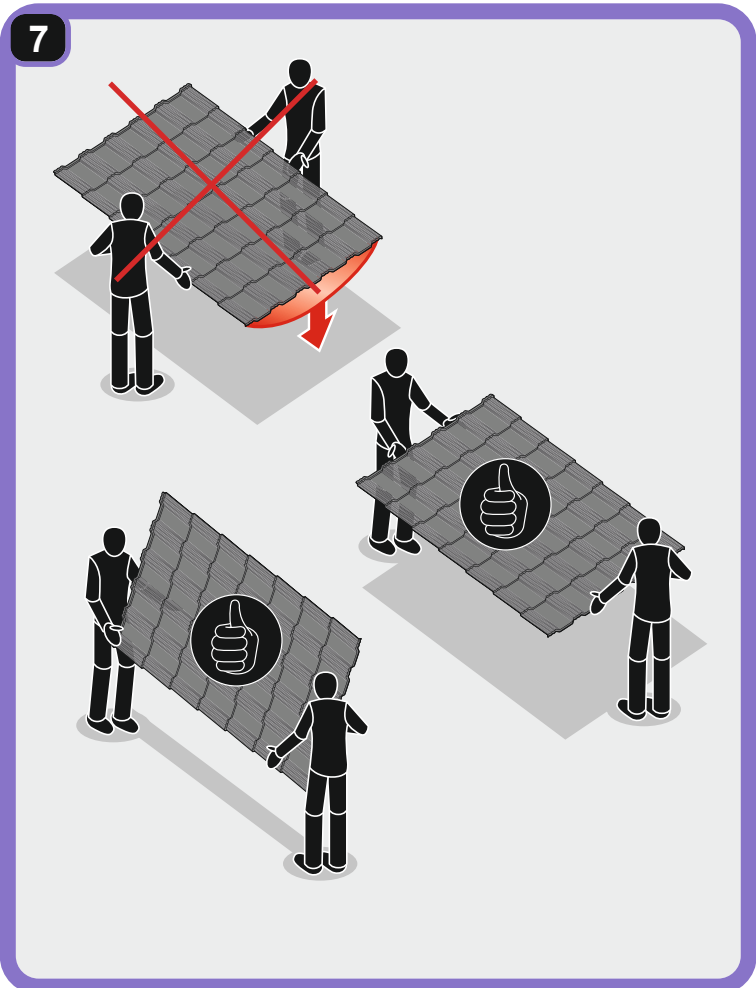
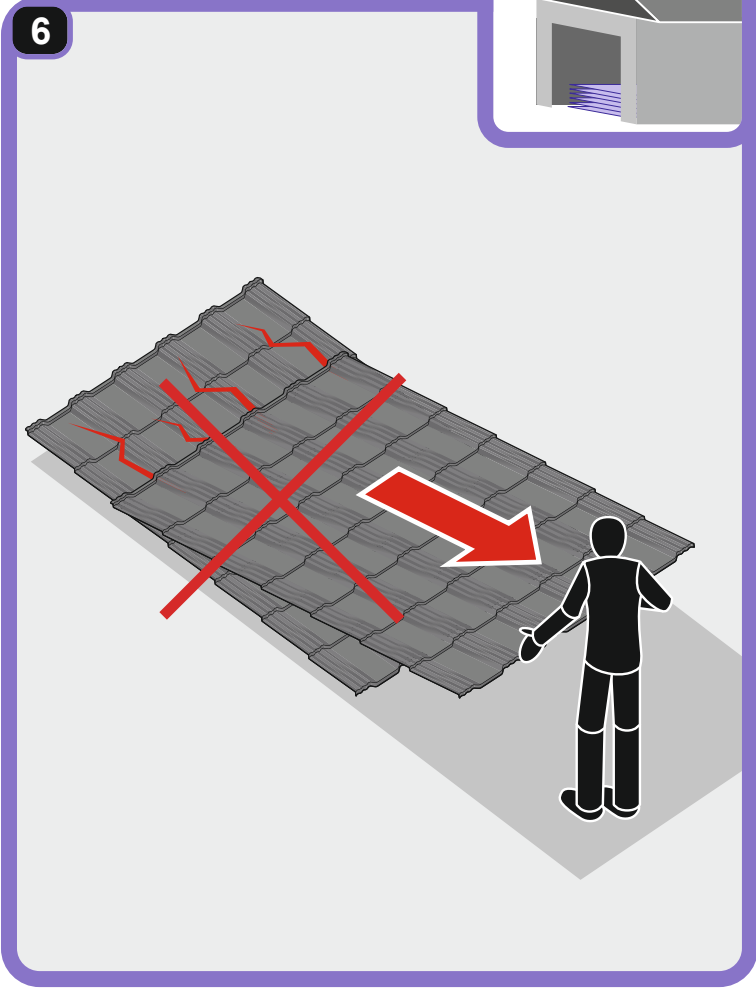
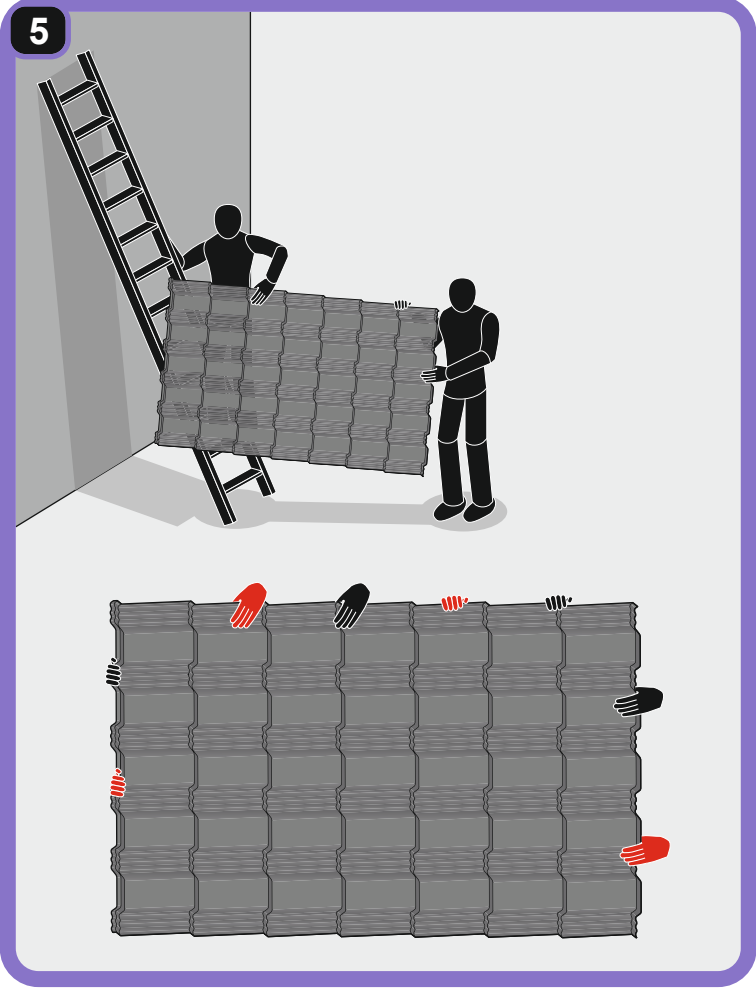
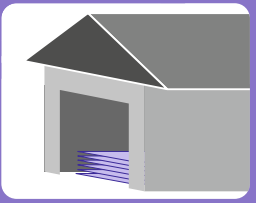



BLACHOTRAPEZ spol. s r. o.
Šmolovy 254,
580 01 Havlíčkův Brod
tel. 569 333 701, fax. 569 333 700
www.blachotrapez.cz
strechy@blachotrapez.cz

1020

Montáž střešních plechů vyžaduje odborné znalosti a zkušenosti. Tento návod je ilustrativní a nezbavuje dodavatele povinnosti dodržovat pravidla pokrývačské praxe a norem. Způsoby montáže uvedené v tomto návodu slouží jako obecné pokyny. Požadovaný způsob montáže se může lišit od toho, který je uveden v návodu v závislosti na typu střechy nebo regionálním řešení. Pro obecné pokyny a tipy pro instalaci postupujte podle pokynů projektanta nebo kontaktujte naše oddělení technické podpory. Zkušení dodavatelé mají individuální řešení, která společnost BLACHOTRAPEZ akceptuje.